

STK5C4U3XXJGEVB

STK5C4U3xx Series Evaluation Board User's Manual



ON Semiconductor®

www.onsemi.com

Introduction

By using this board, STK5C4U3xx series (DIPS) can be evaluated.

EVAL BOARD USER'S MANUAL

ONPN of EVAL Board	ONPN of IPM	Io
STK5C4U332JGEVB	STK5C4U332J-E	3A

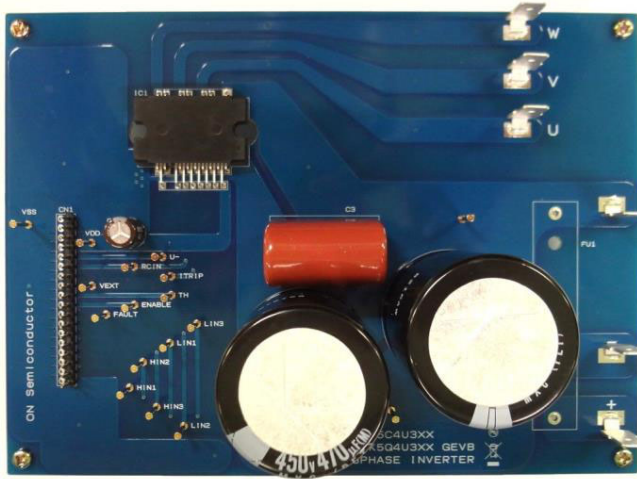

Surface

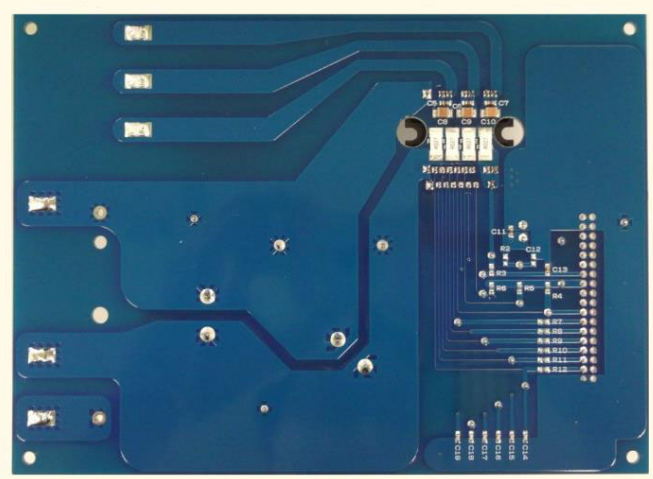

Back side

Figure 1. Evaluation Board Photos

STK5C4U3XXJGEVB

CIRCUIT DIAGRAM

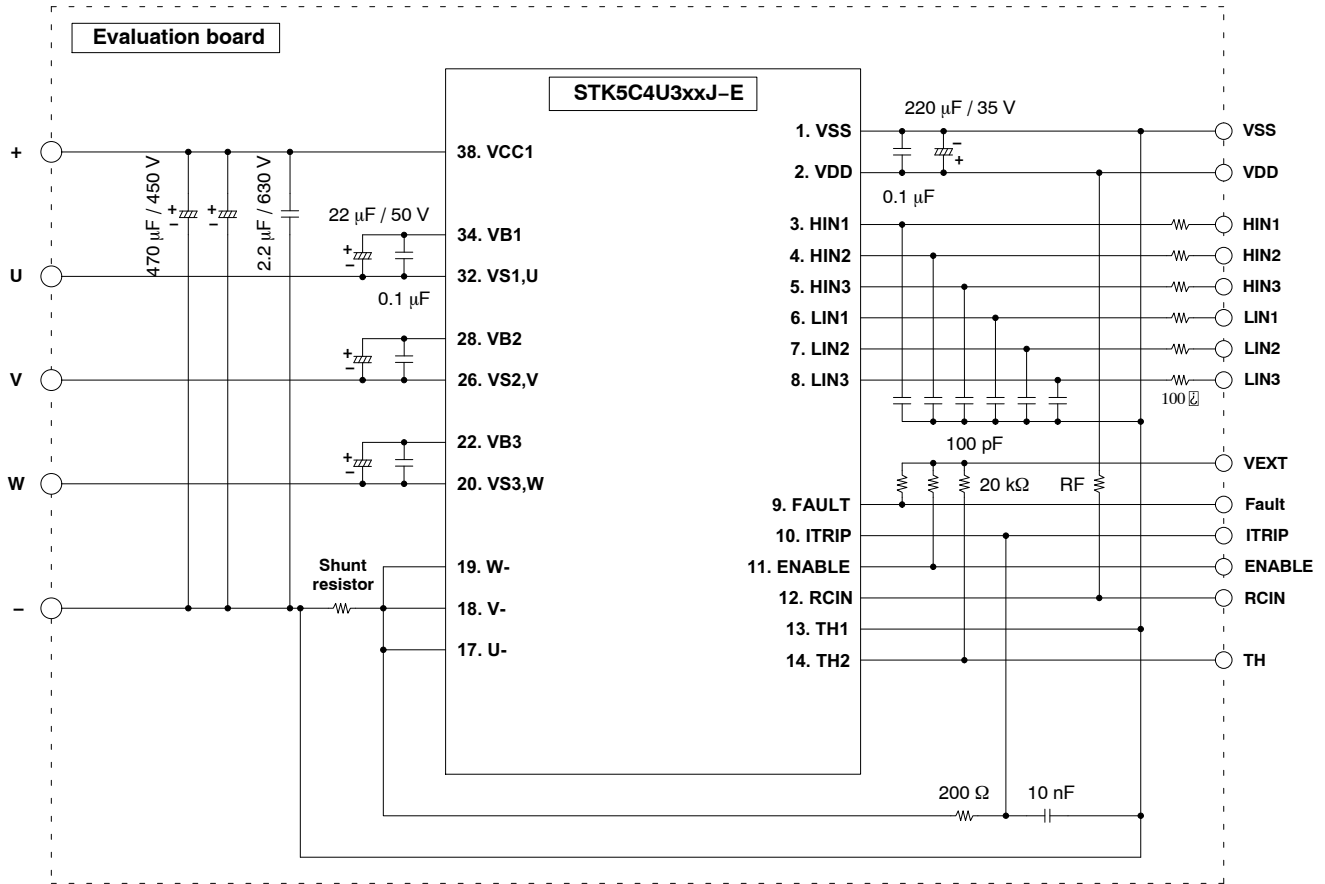

Figure 2. Circuit Diagram

STK5C4U3XXJGEVB

PIN DESCRIPTION

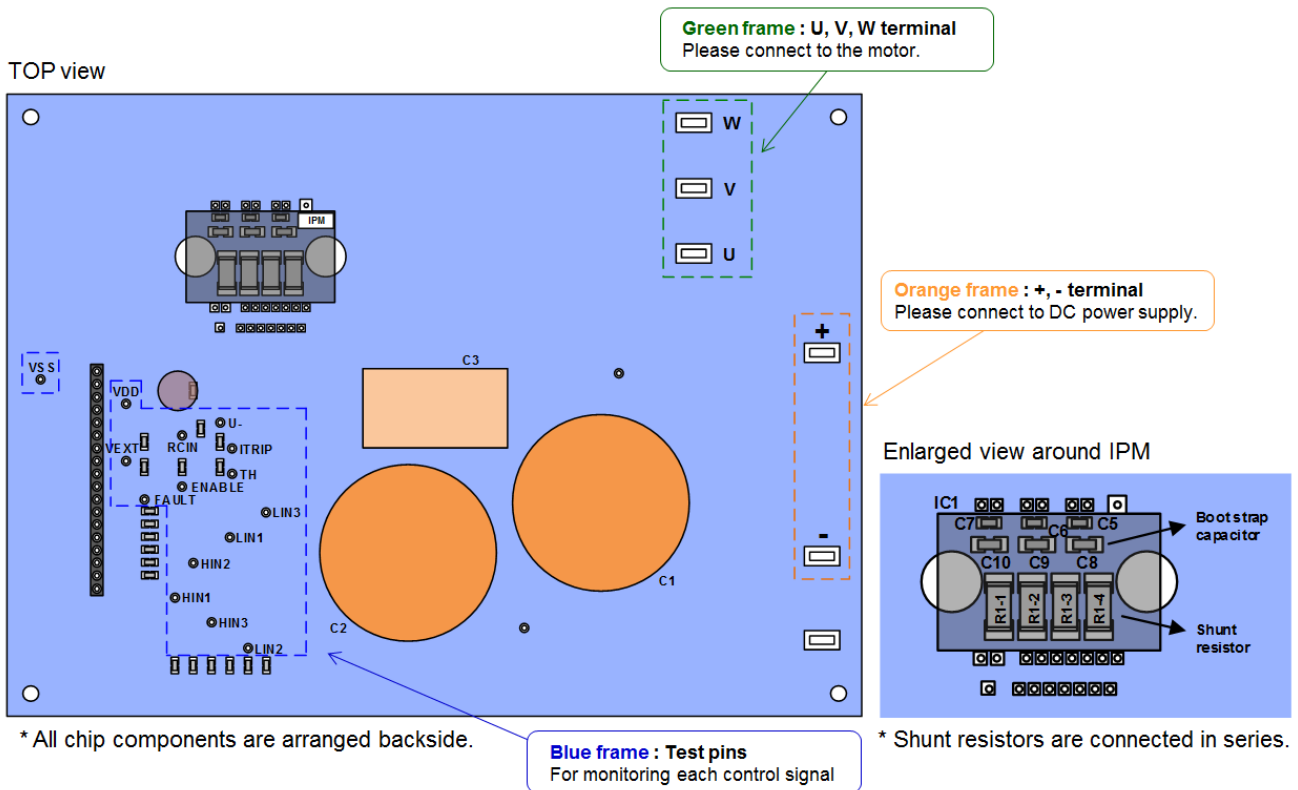

Figure 3. Pin Description 1

Enlarged view around test pins

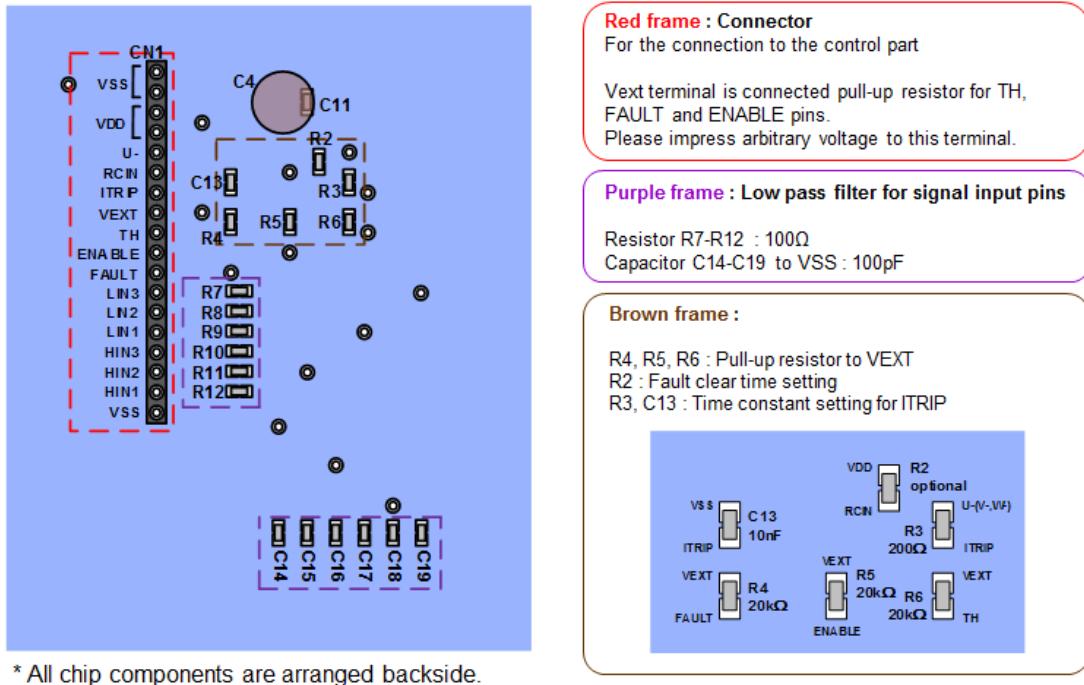

Figure 4. Pin Description 2

STK5C4U3XXJGEVB

OPERATION PROCEDURE

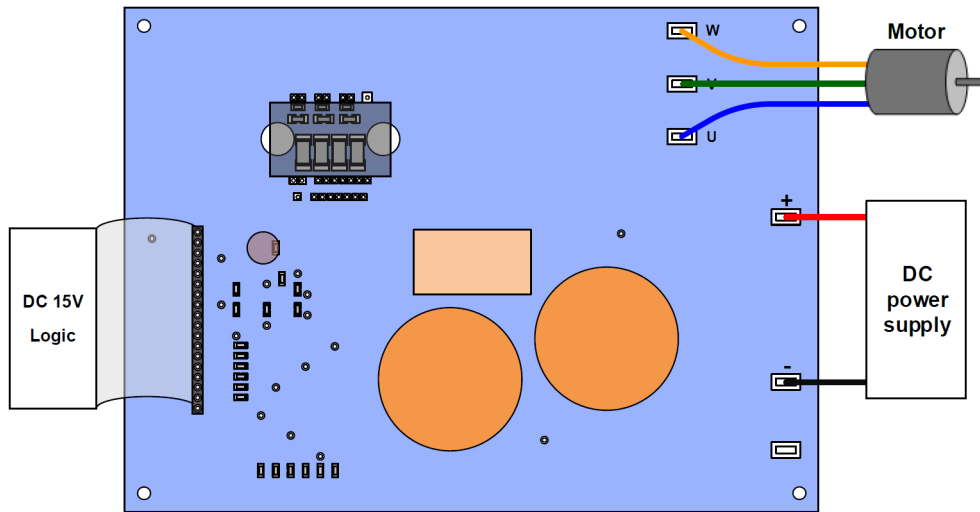

Figure 5. Connection Example

- Step 1. Please connect IPM, each power supply, logic parts, and the motor to the evaluation board, and confirm that each power supply is OFF at this time.
- Step 2. Please impress the power supply of DC 15 V.
- Step 3. Please perform a voltage setup according to specifications, and impress the power supply between the “+” and the “-” terminal.

- Step 4. By inputting signal to the logic part, IPM control is started.
(Therefore, please set electric charge to the boot-strap capacitor of upper side to turn on lower side IGBT before running.)

NOTE: When turning off the power supply part and the logic part, please carry out in the reverse order to above steps.

STK5C4U3XXJGEVB

LAYOUT (TOP VIEW)

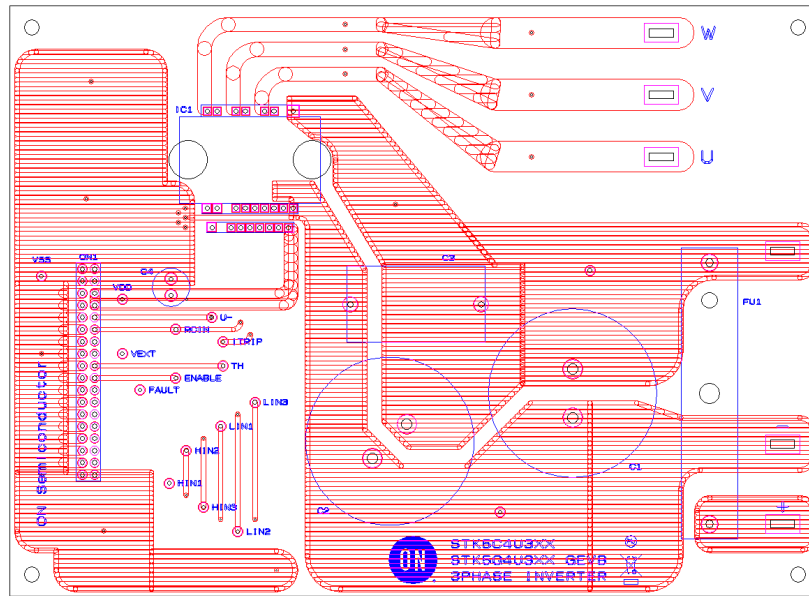

Figure 6. Layout – Surface

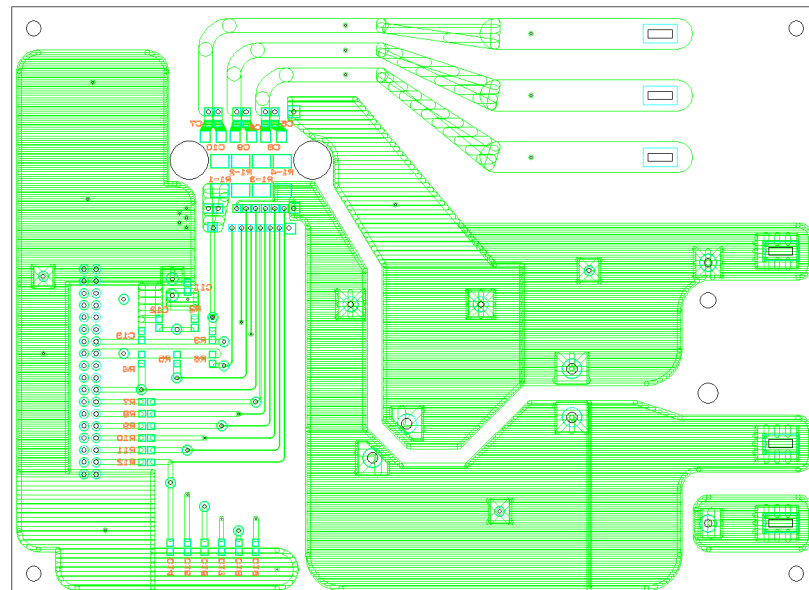

Figure 7. Layout – Back Side

Length: 124 mm

Side: 170 mm

Thickness: 1.6 mm

Rigid double-sided substrate (Material: FR-4)

Both sides resist coating

Copper foil thickness: 70 μ m

STK5C4U3XXJGEVB

BILL OF MATERIALS

Table 1. BILL OF MATERIALS

Designator	Qty	Description	Value	Tolerance	Footprint	Manufacturer	Manufacturer Part Number	Substitution Allowed
R1-1 - R1-4	4	Shunt resistor	27 mΩ / 2 W	±1%	SMD 6432	SUSUMU	KRL3264E-C-R027-F (for 332)	Yes
R2	1	Setting fault clear time / resistor	optional		SMD 1608			Yes
R3	1	Setting time constant / resistor	200 Ω / 0.1 W	±1%	SMD 1608	KOA	RK73H1JTTD2000F	Yes
R4 - R6	3	Fault, ENABLE, TH pull-up / resistor	20 kΩ / 0.1 W	±1%	SMD 1608	KOA	RK73H1JTTD2002F	Yes
R7 - R12	6	Signal input low pass filter / resistor	100 Ω / 0.1 W	±1%	SMD 1608	KOA	RK73H1JTTD1000F	Yes
C1, C2	2	Aluminum electrolytic capacitor, Plus - Minus	470 μF / 450 V	±20%	Through- hole	Rubycon	450MXC470MEFCSN35X50	Yes
C3	1	Film capacitor Plus - Minus, Snubber	2.2 μF / 630 V	±5%	Through- hole	PANASONIC	ECQE6225JT	Yes
C4	1	Aluminum electrolytic capacitor, VDD - VSS	220 μF / 35 V	±20%	Through- hole	Nippon Chemi-Con	EKMG350ELL221MHB5D	Yes
C5 - C7, C11	4	VBx - VSx, VDD - VSS / capacitor	0.1 μF / 50 V	±10%	SMD 1608	MURATA	GRM188B31H104K	Yes
C8 - C10	3	VBx - VSx / capacitor	22 μF / 25 V	±20%	SMD 3225	MURATA	GRM32ER71E226ME15	Yes
C13	1	Setting time constant / capacitor	10 nF / 50 V	±10%	SMD 1608	MURATA	GRM188B11H103K	Yes
C14 - C19	6	Signal input low pass filter / capacitor	100 pF / 50 V	±5%	SMD 1608	MURATA	GRM1882C1H101J	Yes
CN1	1	Header - 18 Pin			Through- hole 2.54 pitch	HIROSE ELECTRIC	A2-18PA-2.54DSA(71)	Yes
VSS, VDD, U-, RCIN, ITRIP, VEXT, TH, ENABLE, FAULT, HIN1-3, LIN1-3, +, -	17	Test Pins			Through- hole	Mac8	ST-1-3	Yes
U, V, W, +, -	5	Faston terminal (Tab)			Through- hole			Yes
IC1	1	Inverter IPM			DIP-38	ON Semiconductor	STK5C4U3xxJ-E	No

NOTE All Components are lead free.

STK5C4U3XXJGEVB

HEAT SINK MOUNTING

Table 2. MOUNTING CONDITION

Item	Recommended Condition
Pitch	26.0 ± 0.1 mm (Please refer to Package Outline Diagram)
Screw	Diameter: M3 Bind machine screw, Truss machine screw, Pan machine screw
Washer	Plane washer Don't use spring washer. The size is D = 7 mm, d = 3.2 mm and t = 0.5 mm (Figure 9) JIS B 1256
Heat Sink	Material: copper or Aluminum Warpage (the surface that contacts IPM): -50 ~ 50 μm Screw holes must be countersunk. No contamination on the heat sink surface that contacts IPM.
Torque	Final tightening: 0.4 ~ 0.6 Nm Temporary tightening: 50 ~ 60% of final tightening
Grease	Silicone grease Thickness: 50 ~ 100 μm Uniformly apply silicone grease to whole back. (Figure 10)

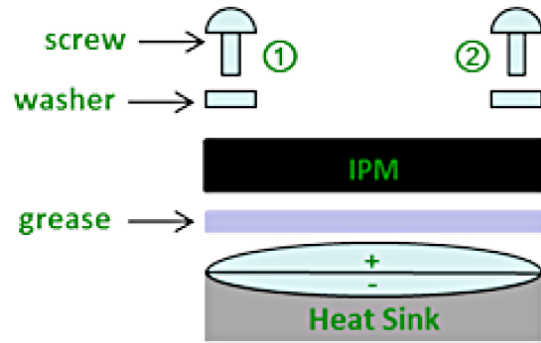

Figure 8. Mounting Composition

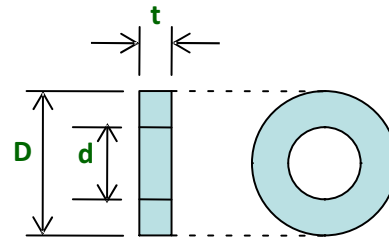

Figure 9. Size of Washer

Procedure for the Heat Sink Mounting

1st step: Tighten the screws until the torque of temporary tightening while maintaining the balance of left (1) and right (2).

2nd step: Tighten them until the torque of final tightening.

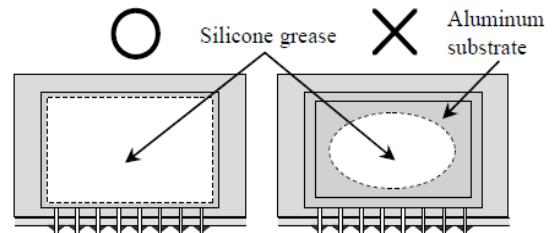

Figure 10. Grease Application

ON Semiconductor and the ON Semiconductor logo are trademarks of Semiconductor Components Industries, LLC dba ON Semiconductor or its subsidiaries in the United States and/or other countries. ON Semiconductor owns the rights to a number of patents, trademarks, copyrights, trade secrets, and other intellectual property. A listing of ON Semiconductor's product/patent coverage may be accessed at www.onsemi.com/site/pdf/Patent-Marking.pdf. ON Semiconductor is an Equal Opportunity/Affirmative Action Employer. This literature is subject to all applicable copyright laws and is not for resale in any manner.

The evaluation board/kit (research and development board/kit) (hereinafter the "board") is not a finished product and is as such not available for sale to consumers. The board is only intended for research, development, demonstration and evaluation purposes and should as such only be used in laboratory/development areas by persons with an engineering/technical training and familiar with the risks associated with handling electrical/mechanical components, systems and subsystems. This person assumes full responsibility/liability for proper and safe handling. Any other use, resale or redistribution for any other purpose is strictly prohibited.

The board is delivered "AS IS" and without warranty of any kind including, but not limited to, that the board is production-worthy, that the functions contained in the board will meet your requirements, or that the operation of the board will be uninterrupted or error free. ON Semiconductor expressly disclaims all warranties, express, implied or otherwise, including without limitation, warranties of fitness for a particular purpose and non-infringement of intellectual property rights.

ON Semiconductor reserves the right to make changes without further notice to any board.

You are responsible for determining whether the board will be suitable for your intended use or application or will achieve your intended results. Prior to using or distributing any systems that have been evaluated, designed or tested using the board, you agree to test and validate your design to confirm the functionality for your application. Any technical, applications or design information or advice, quality characterization, reliability data or other services provided by ON Semiconductor shall not constitute any representation or warranty by ON Semiconductor, and no additional obligations or liabilities shall arise from ON Semiconductor having provided such information or services.

The boards are not designed, intended, or authorized for use in life support systems, or any FDA Class 3 medical devices or medical devices with a similar or equivalent classification in a foreign jurisdiction, or any devices intended for implantation in the human body. Should you purchase or use the board for any such unintended or unauthorized application, you shall indemnify and hold ON Semiconductor and its officers, employees, subsidiaries, affiliates, and distributors harmless against all claims, costs, damages, and expenses, and reasonable attorney fees arising out of, directly or indirectly, any claim of personal injury or death associated with such unintended or unauthorized use, even if such claim alleges that ON Semiconductor was negligent regarding the design or manufacture of the board.

This evaluation board/kit does not fall within the scope of the European Union directives regarding electromagnetic compatibility, restricted substances (RoHS), recycling (WEEE), FCC, CE or UL, and may not meet the technical requirements of these or other related directives.

FCC WARNING – This evaluation board/kit is intended for use for engineering development, demonstration, or evaluation purposes only and is not considered by ON Semiconductor to be a finished end product fit for general consumer use. It may generate, use, or radiate radio frequency energy and has not been tested for compliance with the limits of computing devices pursuant to part 15 of FCC rules, which are designed to provide reasonable protection against radio frequency interference. Operation of this equipment may cause interference with radio communications, in which case the user shall be responsible, at its expense, to take whatever measures may be required to correct this interference.

ON Semiconductor does not convey any license under its patent rights nor the rights of others.

LIMITATIONS OF LIABILITY: ON Semiconductor shall not be liable for any special, consequential, incidental, indirect or punitive damages, including, but not limited to the costs of requalification, delay, loss of profits or goodwill, arising out of or in connection with the board, even if ON Semiconductor is advised of the possibility of such damages. In no event shall ON Semiconductor's aggregate liability from any obligation arising out of or in connection with the board, under any theory of liability, exceed the purchase price paid for the board, if any.

For more information and documentation, please visit www.onsemi.com.

PUBLICATION ORDERING INFORMATION

LITERATURE FULFILLMENT:

Email Requests to: orderlit@onsemi.com

ON Semiconductor Website: www.onsemi.com

TECHNICAL SUPPORT

North American Technical Support:

Voice Mail: 1 800-282-9855 Toll Free USA/Canada

Phone: 011 421 33 790 2910

Europe, Middle East and Africa Technical Support:

Phone: 00421 33 790 2910

For additional information, please contact your local Sales Representative