

# MBR41H100CT, NRVBB41H100CT Series

## Switch-mode Power Rectifier 100 V, 40 A

### Features and Benefits

- Low Forward Voltage: 0.67 V @ 125°C
- Low Power Loss/High Efficiency
- High Surge Capacity
- 175°C Operating Junction Temperature
- 40 A Total (20 A Per Diode Leg)
- Guard-Ring for Stress Protection
- NRVBB Prefix for Automotive and Other Applications Requiring Unique Site and Control Change Requirements; AEC-Q101 Qualified and PPAP Capable
- These Devices are Pb-Free, Halogen Free/BFR Free and are RoHS Compliant
- MBR41H100CTH and MBRB41H100CT-1H are Halide-Free

### Applications

- Power Supply – Output Rectification
- Power Management
- Instrumentation

### Mechanical Characteristics:

- Case: Epoxy, Molded
- Epoxy Meets UL 94 V-0 @ 0.125 in
- Weight (Approximately): 1.9 Grams (TO-220)  
1.7 Grams (D<sup>2</sup>PAK)  
1.5 Grams (TO-262)
- Finish: All External Surfaces Corrosion Resistant and Terminal Leads are Readily Solderable
- Lead Temperature for Soldering Purposes:  
260°C Max. for 10 Seconds



ON Semiconductor®

[www.onsemi.com](http://www.onsemi.com)

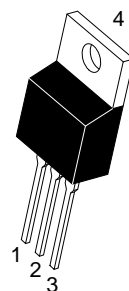
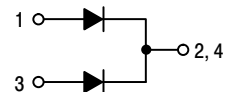

TO-220  
CASE 221A  
STYLE 6

### MARKING DIAGRAMS

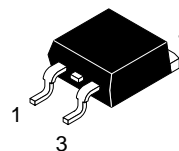
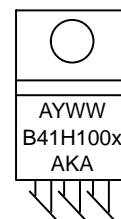

D<sup>2</sup>PAK 3  
CASE 418B  
STYLE 3

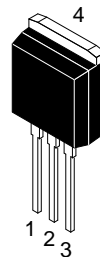

I<sup>2</sup>PAK (TO-262)  
CASE 418D  
STYLE 3

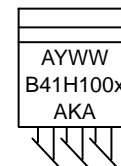

A = Assembly Location  
Y = Year  
WW = Work Week  
x = G or H  
G = Pb-Free Package  
H = Halide-Free Package  
AKA = Polarity Designator

### ORDERING INFORMATION

See detailed ordering and shipping information in the package dimensions section on page 6 of this data sheet.

## MBR41H100CT, NRVBB41H100CT Series

### MAXIMUM RATINGS (Per Diode Leg)

| Rating   | Symbol                          | Value           | Unit             |
|--|---------------------------------|-----------------|------------------|
| Peak Repetitive Reverse Voltage<br>Working Peak Reverse Voltage<br>DC Blocking Voltage                     | $V_{RRM}$<br>$V_{RWM}$<br>$V_R$ | 100             | V                |
| Average Rectified Forward Current<br>(Rated $V_R$ ) $T_C = 150^\circ\text{C}$                              | $I_{F(AV)}$                     | 20              | A                |
| Peak Repetitive Forward Current<br>(Rated $V_R$ , Square Wave, 20 kHz) $T_C = 145^\circ\text{C}$           | $I_{FRM}$                       | 40              | A                |
| Nonrepetitive Peak Surge Current<br>(Surge applied at rated load conditions halfwave, single phase, 60 Hz) | $I_{FSM}$                       | 350             | A                |
| Operating Junction Temperature (Note 1)  | $T_J$                           | +175            | $^\circ\text{C}$ |
| Storage Temperature  | $T_{stg}$                       | -65 to +175     | $^\circ\text{C}$ |
| Voltage Rate of Change (Rated $V_R$ )  | $dv/dt$                         | 10,000          | V/ $\mu\text{s}$ |
| Controlled Avalanche Energy (see test conditions in Figures 10 and 11)                                     | $W_{AVAIL}$                     | 400             | mJ               |
| ESD Ratings:<br>Machine Model = C<br>Human Body Model = 3B   |                                 | > 400<br>> 8000 | V                |

Stresses exceeding those listed in the Maximum Ratings table may damage the device. If any of these limits are exceeded, device functionality should not be assumed, damage may occur and reliability may be affected.

1. The heat generated must be less than the thermal conductivity from Junction-to-Ambient:  $dP_D/dT_J < 1/R_{\theta JA}$ .

### THERMAL CHARACTERISTICS (Per Diode Leg)

| Characteristic  | Symbol                             | Value     | Unit               |
|---|------------------------------------|-----------|--------------------|
| Maximum Thermal Resistance<br>Junction-to-Case<br>Junction-to-Ambient | $R_{\theta JC}$<br>$R_{\theta JA}$ | 2.0<br>70 | $^\circ\text{C/W}$ |

### ELECTRICAL CHARACTERISTICS (Per Diode Leg)

| Characteristic   | Symbol | Value                        | Unit |
|--|--------|------------------------------|------|
| Maximum Instantaneous Forward Voltage (Note 2)<br>( $I_F = 20\text{ A}$ , $T_C = 25^\circ\text{C}$ )<br>( $I_F = 20\text{ A}$ , $T_C = 125^\circ\text{C}$ )<br>( $I_F = 40\text{ A}$ , $T_C = 25^\circ\text{C}$ )<br>( $I_F = 40\text{ A}$ , $T_C = 125^\circ\text{C}$ ) | $V_F$  | 0.80<br>0.67<br>0.90<br>0.76 | V    |
| Maximum Instantaneous Reverse Current (Note 2)<br>(Rated DC Voltage, $T_C = 125^\circ\text{C}$ )<br>(Rated DC Voltage, $T_C = 25^\circ\text{C}$ )  | $i_R$  | 10<br>0.01                   | mA   |

Product parametric performance is indicated in the Electrical Characteristics for the listed test conditions, unless otherwise noted. Product performance may not be indicated by the Electrical Characteristics if operated under different conditions.

2. Pulse Test: Pulse Width = 300  $\mu\text{s}$ , Duty Cycle  $\leq 2.0\%$ .

# MBR41H100CT, NRVBB41H100CT Series

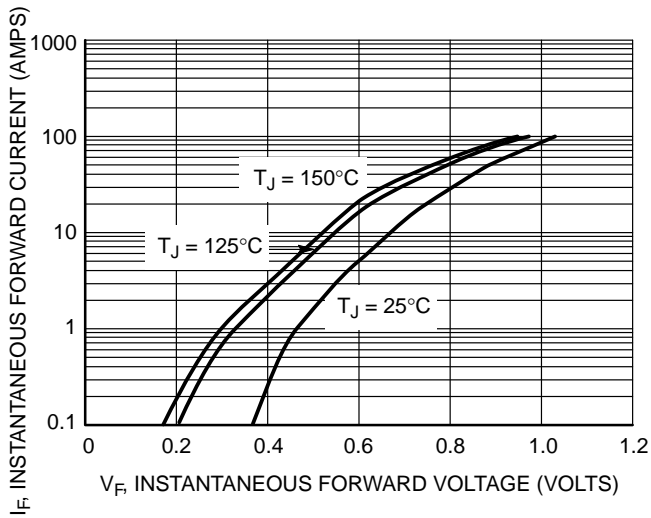

Figure 1. Typical Forward Voltage

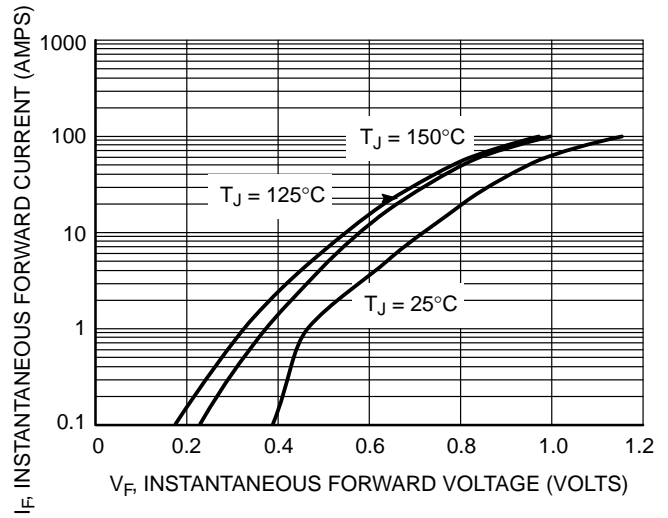

Figure 2. Maximum Forward Voltage

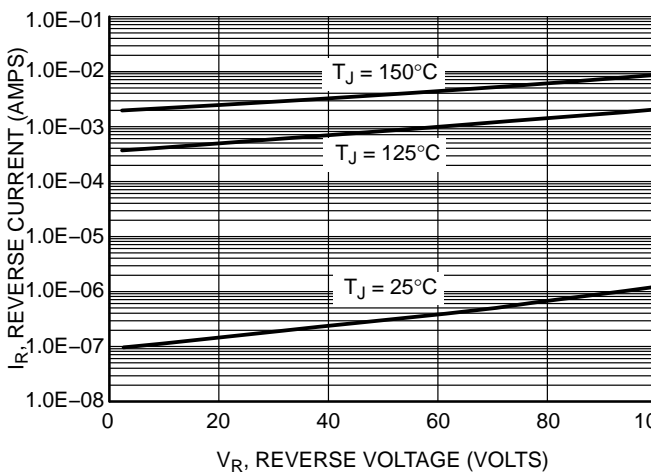

Figure 3. Typical Reverse Current

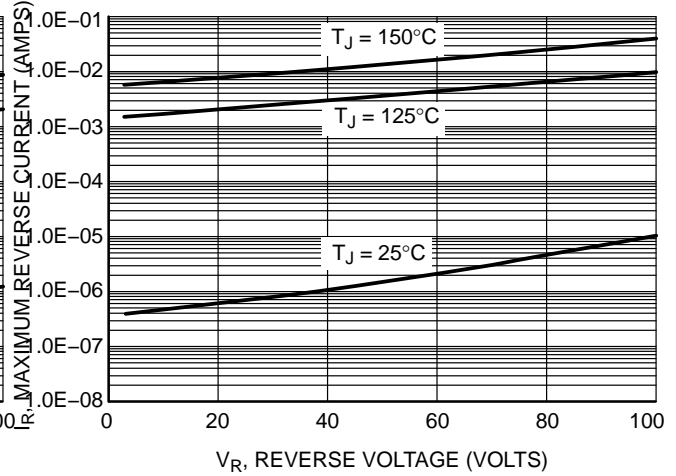

Figure 4. Maximum Reverse Current

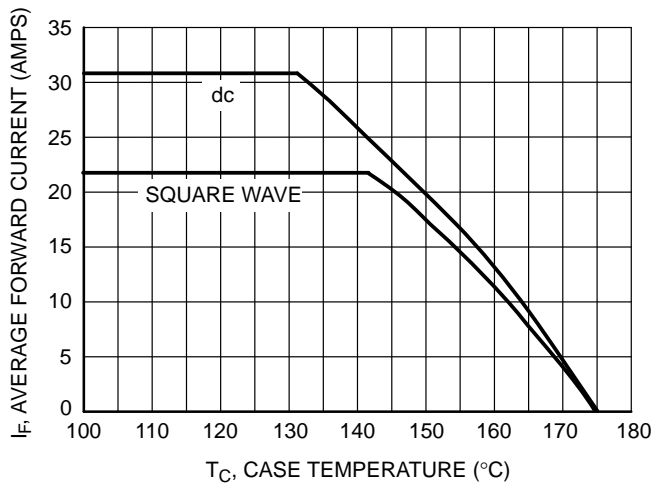

Figure 5. Current Derating

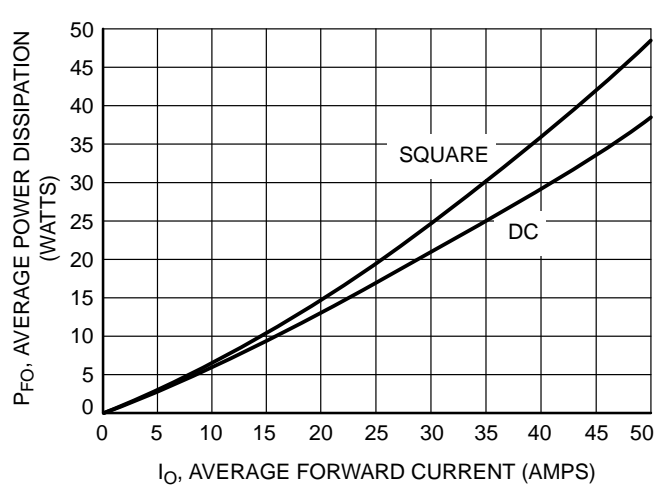

Figure 6. Forward Power Dissipation

# MBR41H100CT, NRVBB41H100CT Series

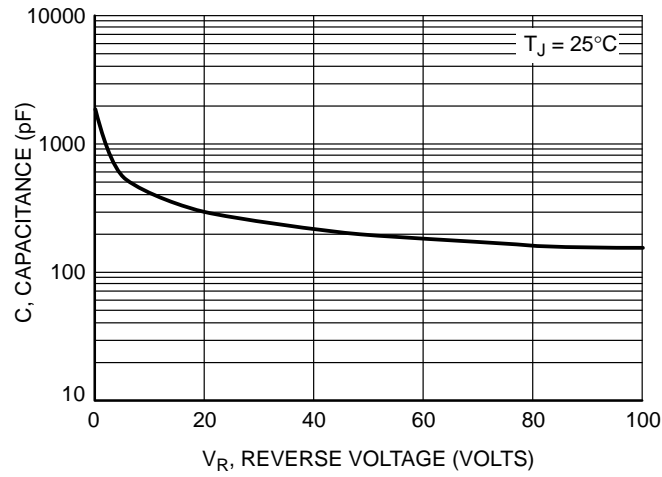

Figure 7. Capacitance

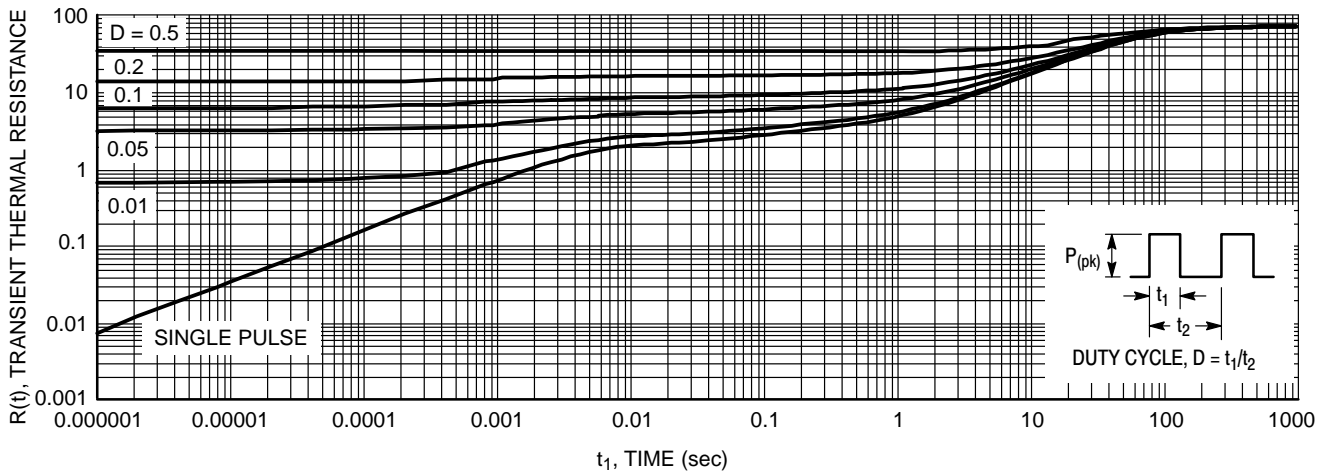

Figure 8. Thermal Response Junction-to-Ambient

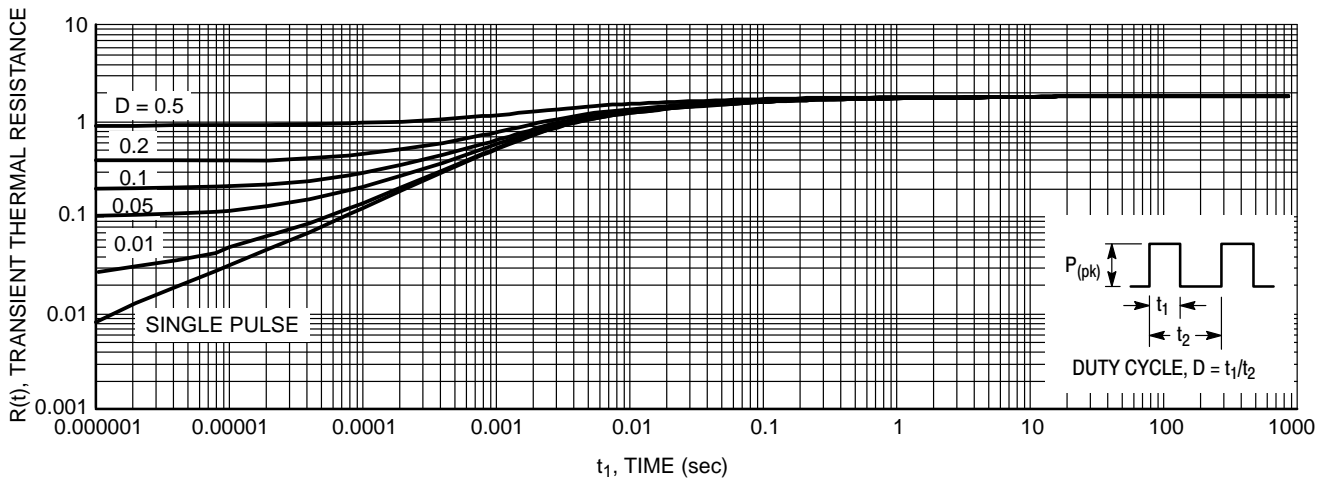

Figure 9. Thermal Response Junction-to-Case

## MBR41H100CT, NRVBB41H100CT Series

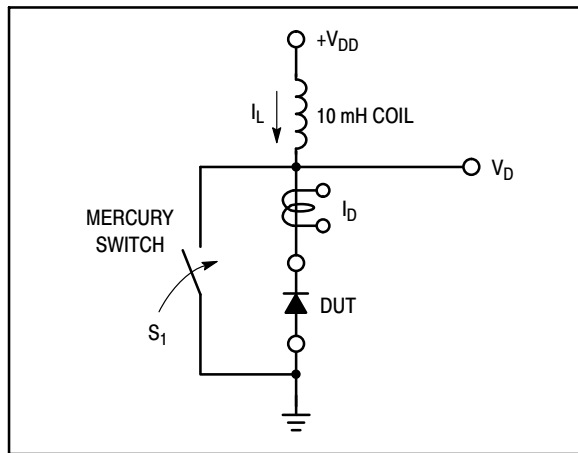

Figure 10. Test Circuit

The unclamped inductive switching circuit shown in Figure 10 was used to demonstrate the controlled avalanche capability of this device. A mercury switch was used instead of an electronic switch to simulate a noisy environment when the switch was being opened.

When  $S_1$  is closed at  $t_0$  the current in the inductor  $I_L$  ramps up linearly; and energy is stored in the coil. At  $t_1$  the switch is opened and the voltage across the diode under test begins to rise rapidly, due to  $di/dt$  effects, when this induced voltage reaches the breakdown voltage of the diode, it is clamped at  $BV_{DUT}$  and the diode begins to conduct the full load current which now starts to decay linearly through the diode, and goes to zero at  $t_2$ .

By solving the loop equation at the point in time when  $S_1$  is opened; and calculating the energy that is transferred to the diode it can be shown that the total energy transferred is equal to the energy stored in the inductor plus a finite amount of energy from the  $V_{DD}$  power supply while the diode is in breakdown (from  $t_1$  to  $t_2$ ) minus any losses due to finite component resistances. Assuming the component resistive

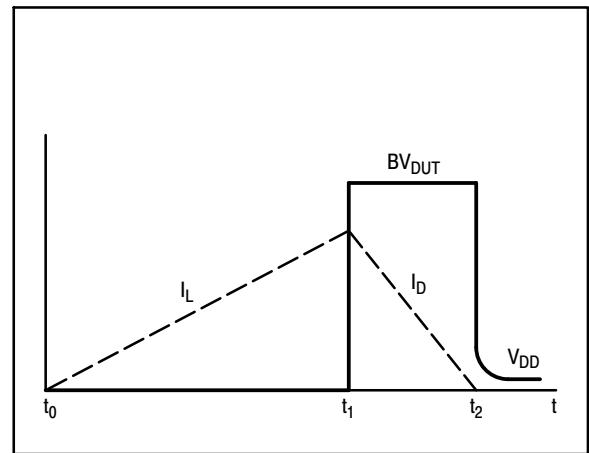

Figure 11. Current-Voltage Waveforms

elements are small Equation (1) approximates the total energy transferred to the diode. It can be seen from this equation that if the  $V_{DD}$  voltage is low compared to the breakdown voltage of the device, the amount of energy contributed by the supply during breakdown is small and the total energy can be assumed to be nearly equal to the energy stored in the coil during the time when  $S_1$  was closed, Equation (2).

**EQUATION (1):**

$$W_{AVAL} \approx \frac{1}{2} L I_{LPK}^2 \left( \frac{BV_{DUT}}{BV_{DUT} V_{DD}} \right)$$

**EQUATION (2):**

$$W_{AVAL} \approx \frac{1}{2} L I_{LPK}^2$$

## MBR41H100CT, NRVBB41H100CT Series

### ORDERING INFORMATION

| Device                              | Package                             | Shipping†               |
|-------------------------------------|-------------------------------------|-------------------------|
| MBR41H100CTG                        | TO-220<br>(Pb-Free)                 | 50 Units / Rail         |
| MBR41H100CTH                        | TO-220<br>(Halide-Free)             | 50 Units / Rail         |
| MBRB41H100CT-1G                     | I <sup>2</sup> PAK<br>(Pb-Free)     | 50 Units / Rail         |
| MBRB41H100CT-1H<br>(In Development) | I <sup>2</sup> PAK<br>(Halide-Free) | 50 Units / Rail         |
| MBRB41H100CTT4G                     | D <sup>2</sup> PAK 3<br>(Pb-Free)   | 800 Units / Tape & Reel |
| NRVBB41H100CTT4G*                   | D <sup>2</sup> PAK 3<br>(Pb-Free)   | 800 Units / Tape & Reel |

†For information on tape and reel specifications, including part orientation and tape sizes, please refer to our Tape and Reel Packaging Specifications Brochure, BRD8011/D.

\*NRVBB Prefix for Automotive and Other Applications Requiring Unique Site and Control Change Requirements; AEC-Q100 Qualified and PPAP Capable.

# MBR41H100CT, NRVBB41H100CT Series

## PACKAGE DIMENSIONS

TO-220  
CASE 221A-09  
ISSUE AH

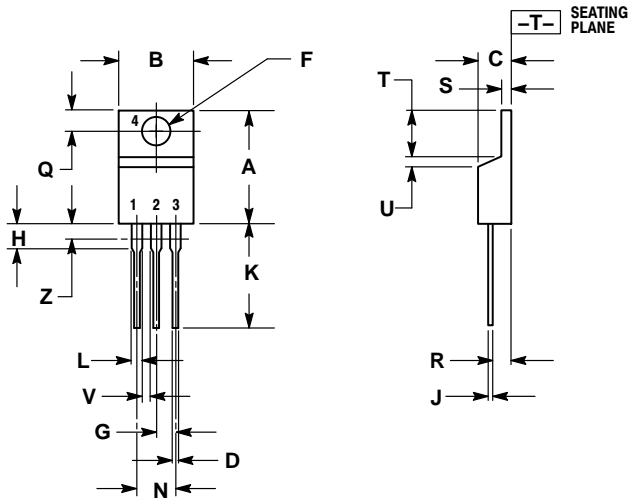

NOTES:

1. DIMENSIONING AND TOLERANCING PER ANSI Y14.5M, 1982.
2. CONTROLLING DIMENSION: INCH.
3. DIMENSION Z DEFINES A ZONE WHERE ALL BODY AND LEAD IRREGULARITIES ARE ALLOWED.

| DIM | INCHES |       | MILLIMETERS |       |
|-----|--------|-------|-------------|-------|
|     | MIN    | MAX   | MIN         | MAX   |
| A   | 0.570  | 0.620 | 14.48       | 15.75 |
| B   | 0.380  | 0.415 | 9.66        | 10.53 |
| C   | 0.160  | 0.190 | 4.07        | 4.83  |
| D   | 0.025  | 0.038 | 0.64        | 0.96  |
| F   | 0.142  | 0.161 | 3.61        | 4.09  |
| G   | 0.095  | 0.105 | 2.42        | 2.66  |
| H   | 0.110  | 0.161 | 2.80        | 4.10  |
| J   | 0.014  | 0.024 | 0.36        | 0.61  |
| K   | 0.500  | 0.562 | 12.70       | 14.27 |
| L   | 0.045  | 0.060 | 1.15        | 1.52  |
| N   | 0.190  | 0.210 | 4.83        | 5.33  |
| Q   | 0.100  | 0.120 | 2.54        | 3.04  |
| R   | 0.080  | 0.110 | 2.04        | 2.79  |
| S   | 0.045  | 0.055 | 1.15        | 1.39  |
| T   | 0.235  | 0.255 | 5.97        | 6.47  |
| U   | 0.000  | 0.050 | 0.00        | 1.27  |
| V   | 0.045  | ---   | 1.15        | ---   |
| Z   | ---    | 0.080 | ---         | 2.04  |

STYLE 6:

- PIN 1. ANODE
- CATHODE
- ANODE
- CATHODE

# MBR41H100CT, NRVBB41H100CT Series

## PACKAGE DIMENSIONS

D<sup>2</sup>PAK 3  
CASE 418B-04  
ISSUE K

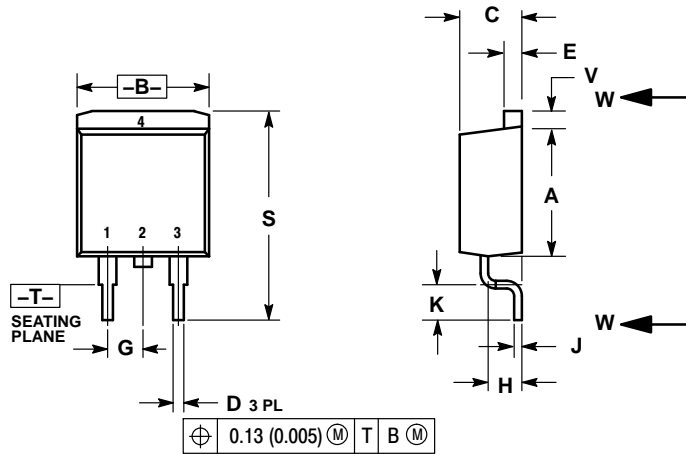

- NOTES:
1. DIMENSIONING AND TOLERANCING PER ANSI Y14.5M, 1982.
  2. CONTROLLING DIMENSION: INCH.
  3. 418B-01 THRU 418B-03 OBSOLETE, NEW STANDARD 418B-04.

| DIM | INCHES    |       | MILLIMETERS |       |
|-----|-----------|-------|-------------|-------|
|     | MIN       | MAX   | MIN         | MAX   |
| A   | 0.340     | 0.380 | 8.64        | 9.65  |
| B   | 0.380     | 0.405 | 9.65        | 10.29 |
| C   | 0.160     | 0.190 | 4.06        | 4.83  |
| D   | 0.020     | 0.035 | 0.51        | 0.89  |
| E   | 0.045     | 0.055 | 1.14        | 1.40  |
| F   | 0.310     | 0.350 | 7.87        | 8.89  |
| G   | 0.100 BSC |       | 2.54 BSC    |       |
| H   | 0.080     | 0.110 | 2.03        | 2.79  |
| J   | 0.018     | 0.025 | 0.46        | 0.64  |
| K   | 0.090     | 0.110 | 2.29        | 2.79  |
| L   | 0.052     | 0.072 | 1.32        | 1.83  |
| M   | 0.280     | 0.320 | 7.11        | 8.13  |
| N   | 0.197 REF |       | 5.00 REF    |       |
| P   | 0.079 REF |       | 2.00 REF    |       |
| R   | 0.039 REF |       | 0.99 REF    |       |
| S   | 0.575     | 0.625 | 14.60       | 15.88 |
| V   | 0.045     | 0.055 | 1.14        | 1.40  |

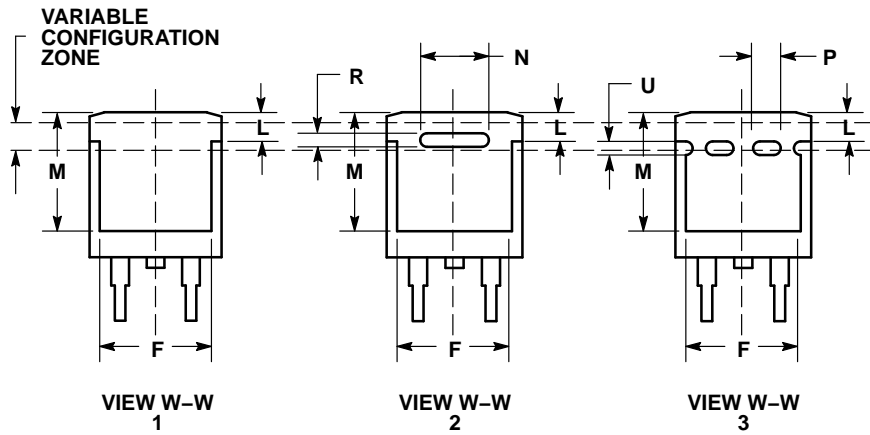

- STYLE 3:  
PIN 1. ANODE  
2. CATHODE  
3. ANODE  
4. CATHODE

### SOLDERING FOOTPRINT\*

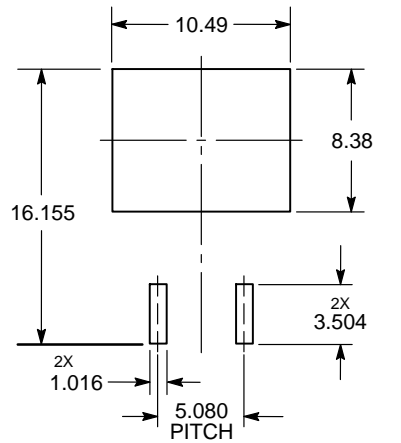

DIMENSIONS: MILLIMETERS

\*For additional information on our Pb-Free strategy and soldering details, please download the ON Semiconductor Soldering and Mounting Techniques Reference Manual, SOLDERRM/D.



# MBR41H100CT, NRVBB41H100CT Series

## PACKAGE DIMENSIONS

I<sup>2</sup>PAK (TO-262)  
CASE 418D  
ISSUE D

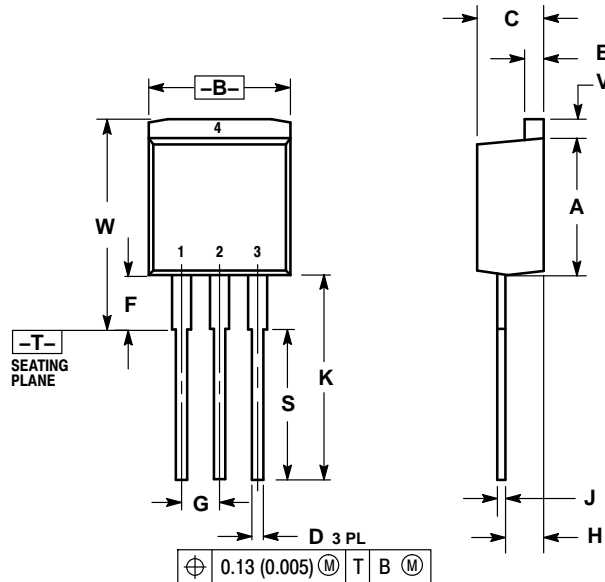

- NOTES:  
1. DIMENSIONING AND TOLERANCING PER ANSI Y14.5M, 1982.  
2. CONTROLLING DIMENSION: INCH.

| DIM | INCHES    |       | MILLIMETERS |       |
|-----|-----------|-------|-------------|-------|
|     | MIN       | MAX   | MIN         | MAX   |
| A   | 0.335     | 0.380 | 8.51        | 9.65  |
| B   | 0.380     | 0.406 | 9.65        | 10.31 |
| C   | 0.160     | 0.185 | 4.06        | 4.70  |
| D   | 0.026     | 0.035 | 0.66        | 0.89  |
| E   | 0.045     | 0.055 | 1.14        | 1.40  |
| F   | 0.122 REF |       | 3.10 REF    |       |
| G   | 0.100 BSC |       | 2.54 BSC    |       |
| H   | 0.094     | 0.110 | 2.39        | 2.79  |
| J   | 0.013     | 0.025 | 0.33        | 0.64  |
| K   | 0.500     | 0.562 | 12.70       | 14.27 |
| S   | 0.390 REF |       | 9.90 REF    |       |
| V   | 0.045     | 0.070 | 1.14        | 1.78  |
| W   | 0.522     | 0.551 | 13.25       | 14.00 |

- STYLE 3:  
PIN 1. ANODE  
2. CATHODE  
3. ANODE  
4. CATHODE

ON Semiconductor and the  are registered trademarks of Semiconductor Components Industries, LLC (SCILLC) or its subsidiaries in the United States and/or other countries. SCILLC owns the rights to a number of patents, trademarks, copyrights, trade secrets, and other intellectual property. A listing of SCILLC's product/patent coverage may be accessed at [www.onsemi.com/site/pdf/Patent-Marketing.pdf](http://www.onsemi.com/site/pdf/Patent-Marketing.pdf). SCILLC reserves the right to make changes without further notice to any products herein. SCILLC makes no warranty, representation or guarantee regarding the suitability of its products for any particular purpose, nor does SCILLC assume any liability arising out of the application or use of any product or circuit, and specifically disclaims any and all liability, including without limitation special, consequential or incidental damages. "Typical" parameters which may be provided in SCILLC data sheets and/or specifications can and do vary in different applications and actual performance may vary over time. All operating parameters, including "Typicals" must be validated for each customer application by customer's technical experts. SCILLC does not convey any license under its patent rights nor the rights of others. SCILLC products are not designed, intended, or authorized for use as components in systems intended for surgical implant into the body, or other applications intended to support or sustain life, or for any other application in which the failure of the SCILLC product could create a situation where personal injury or death may occur. Should Buyer purchase or use SCILLC products for any such unintended or unauthorized application, Buyer shall indemnify and hold SCILLC and its officers, employees, subsidiaries, affiliates, and distributors harmless against all claims, costs, damages, and expenses, and reasonable attorney fees arising out of, directly or indirectly, any claim of personal injury or death associated with such unintended or unauthorized use, even if such claim alleges that SCILLC was negligent regarding the design or manufacture of the part. SCILLC is an Equal Opportunity/Affirmative Action Employer. This literature is subject to all applicable copyright laws and is not for resale in any manner.

### PUBLICATION ORDERING INFORMATION

**LITERATURE FULFILLMENT:**  
Literature Distribution Center for ON Semiconductor  
P.O. Box 5163, Denver, Colorado 80217 USA  
**Phone:** 303-675-2175 or 800-344-3860 Toll Free USA/Canada  
**Fax:** 303-675-2176 or 800-344-3867 Toll Free USA/Canada  
**Email:** [orderlit@onsemi.com](mailto:orderlit@onsemi.com)

**N. American Technical Support:** 800-282-9855 Toll Free  
USA/Canada  
**Europe, Middle East and Africa Technical Support:**  
Phone: 421 33 790 2910  
**Japan Customer Focus Center**  
Phone: 81-3-5817-1050

**ON Semiconductor Website:** [www.onsemi.com](http://www.onsemi.com)  
**Order Literature:** <http://www.onsemi.com/orderlit>  
For additional information, please contact your local Sales Representative

**MBR41H100CT/D**