

Variant name: TE0741-03-325-2CF

Top View

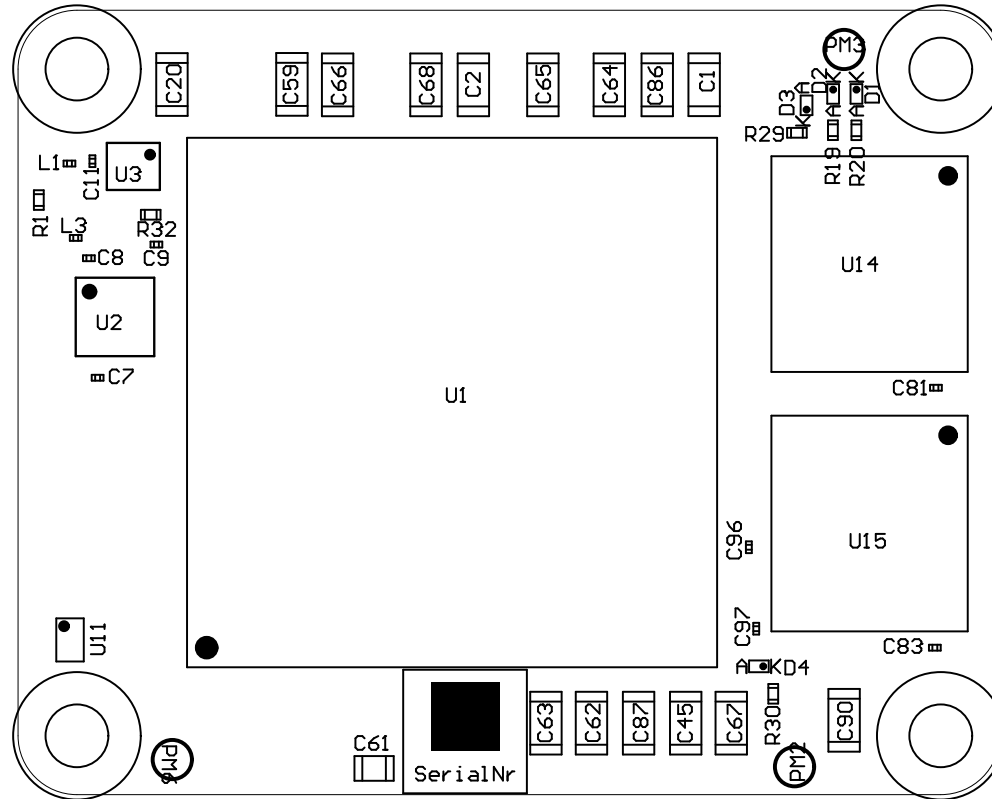

Variant name: TE0741-03-325-2CF

Bottom View

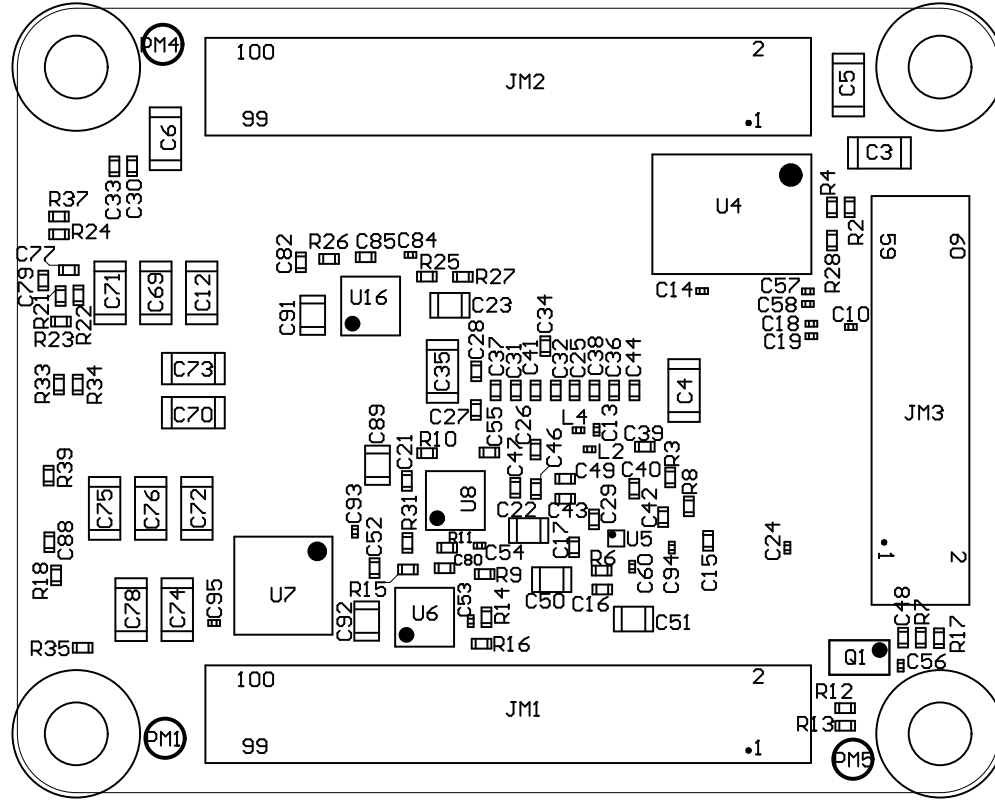

Top View

Top View

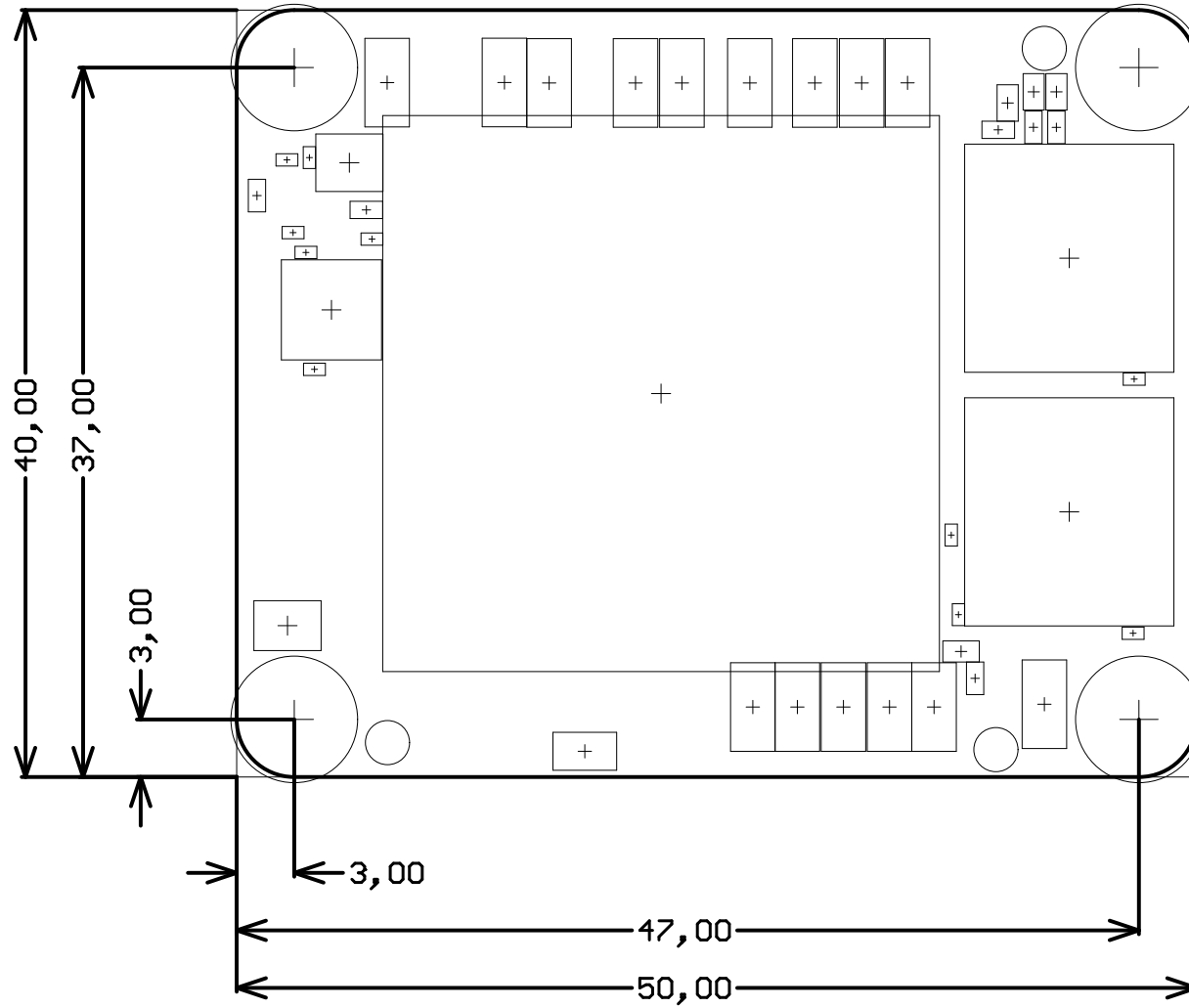

Mounting Holes

Top View

Top View

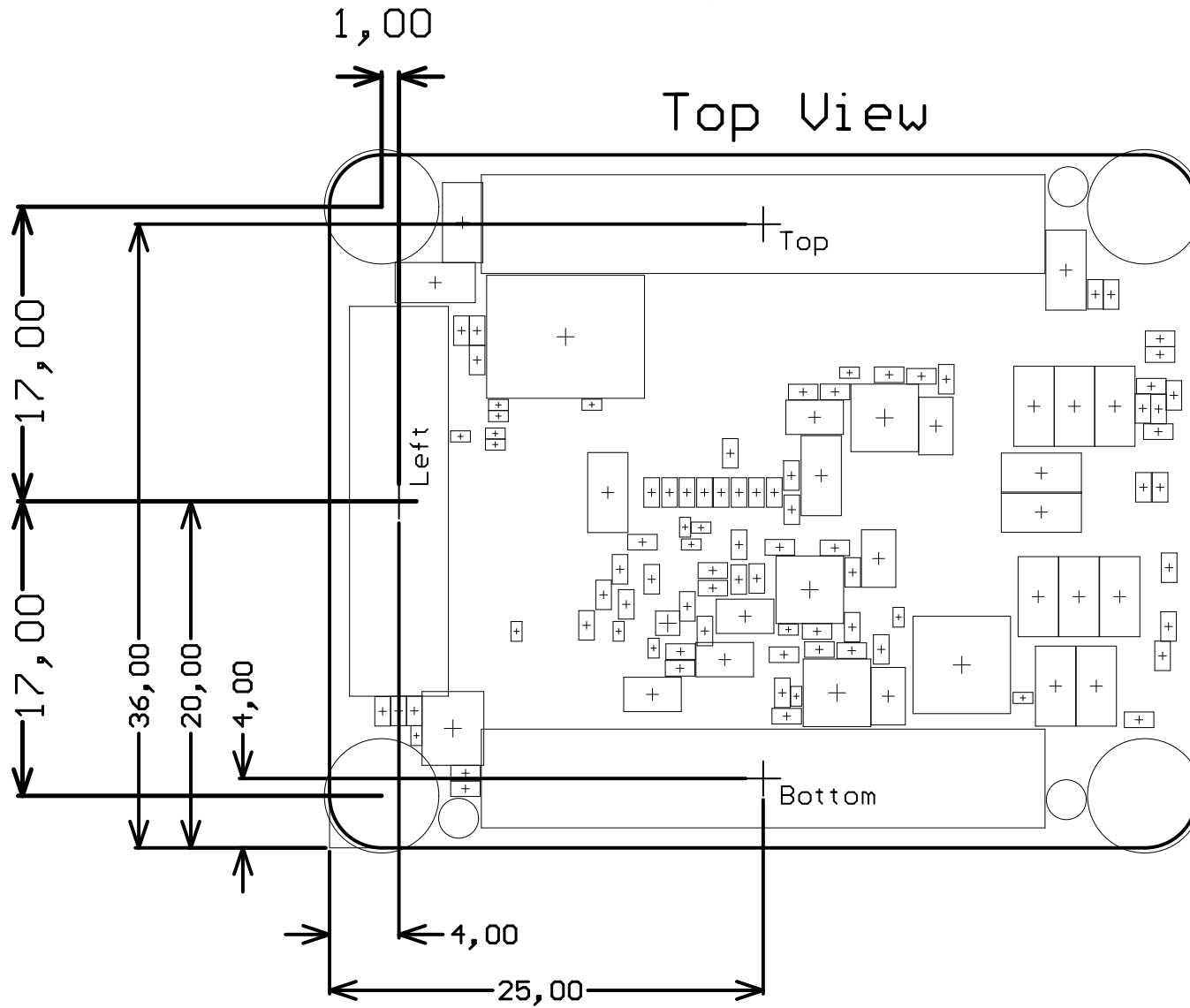

Samtec Connectors