

REVISIONS					
P	LTR	DESCRIPTION	DATE	DWN	APVD
A		INITIAL RELEASE	26OCT2020	TL	HL

NOTE:

- MATERIAL:  
HOUSING: THERMOPLASTIC, UL94 V-0, COLOR: BLACK COLOR.  
CONTACTS: PHOSPHOR BRONZE.
- FINISH:  
CONTACTS: [SEE TABLE]u" MIN. GOLD PLATING ON THE CONTACT AREA,  
3.0um [120u"] MIN. MATTE-TIN ON SOLDER TAIL.  
1.27um [50u"] MIN. NICKEL UNDERPLATED OVERALL.

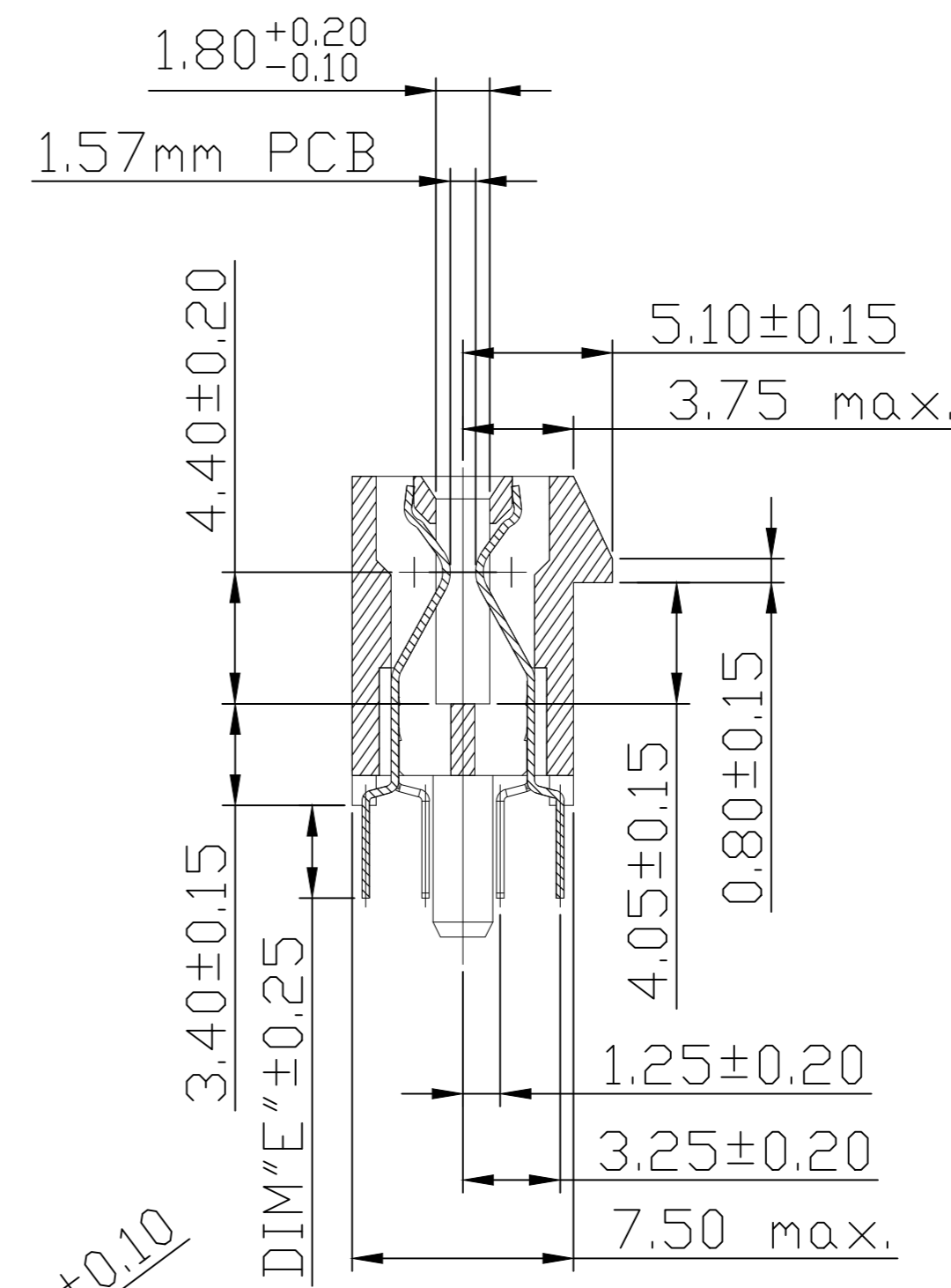
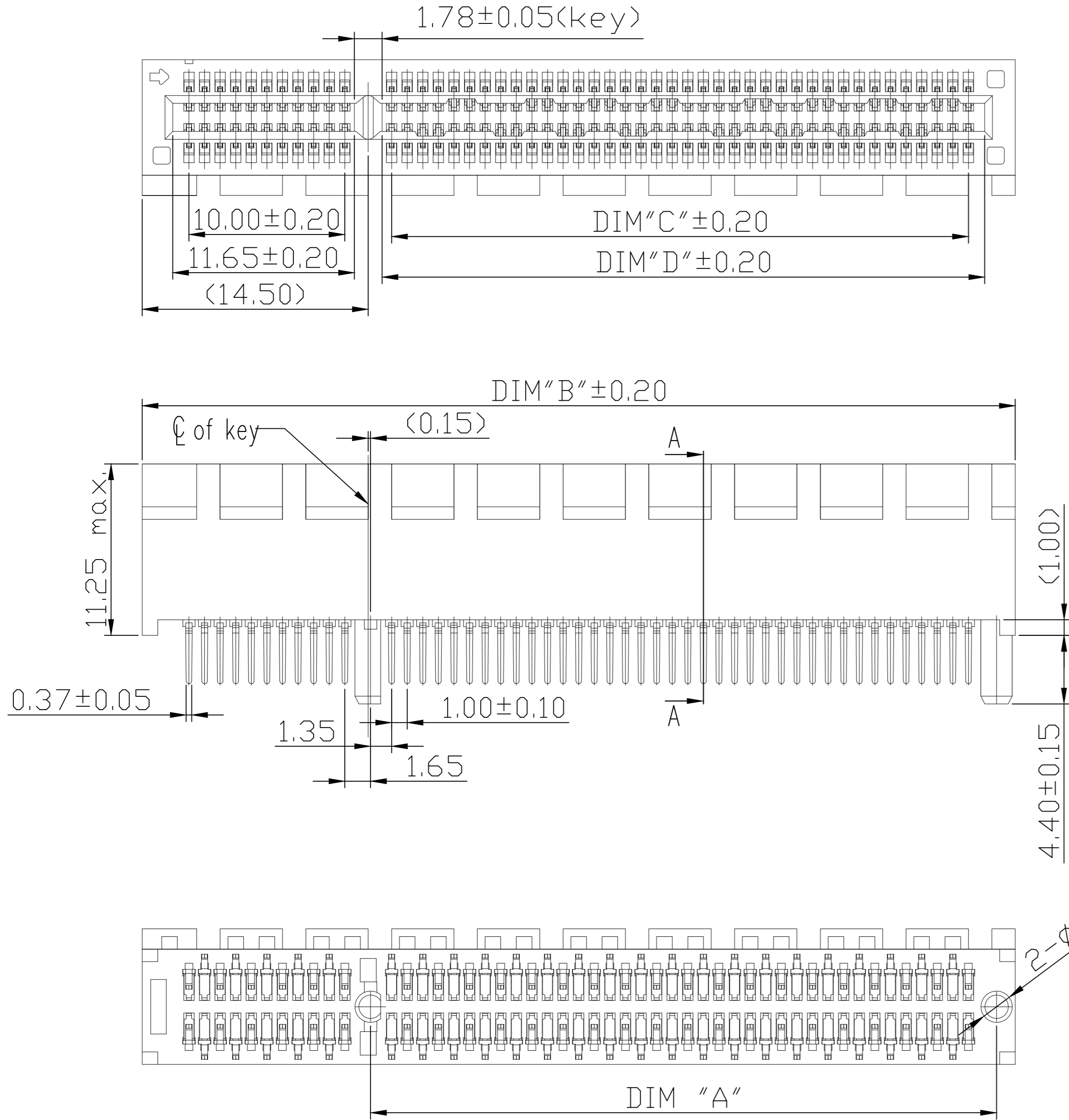

SECTION A-A

CONNECTOR LINK WIDTH	# PDS REF	DIM 'A'	DIM 'B'	DIM 'C'	DIM 'D'	DIM 'E'	PCB THK REF.
X1	36P	9.15	25.00	6.00	7.65	2.30	1.58
X4	64P	23.15	39.00	20.00	21.65	3.10	2.36
X8	98P	40.15	56.00	37.00	38.65		
X16	164P	73.15	89.00	70.00	71.65		

THIS DRAWING IS A CONTROLLED DOCUMENT.

DWN TONY LI 04SEP2019	 TE Connectivity Ltd.	SIZE	CAGE CODE	DRAWING NO	RESTRICTED TO	
CHK ALEX SHOAL 04SEP2019		A2	00779	C=2362375	-	
APVD HOPE LU 04SEP2019		SCALE	4:1	SHEET	1 of 4	REV
PRODUCT SPEC		CUSTOMER DRAWING				A

NAME: PCI EXPRESS CARD EDGE DIP TYPE GEN4 CONNECTOR

APPLICATION SPEC: -

WEIGHT: 0

REVISIONS

P	LTR	DESCRIPTION	DATE	DWN	APVD
-	-	SEE SHEET 1	-	-	-

30u"	3.10	164	5-2362375-4
	3.10	98	5-2362375-3
	3.10	64	5-2362375-2
	3.10	36	5-2362375-1
15u"	3.10	164	4-2362375-4
	3.10	98	4-2362375-3
	3.10	64	4-2362375-2
	3.10	36	4-2362375-1
G/F	3.10	164	3-2362375-4
	3.10	98	3-2362375-3
	3.10	64	3-2362375-2
	3.10	36	3-2362375-1
30u"	2.30	164	2-2362375-4
	2.30	98	2-2362375-3
	2.30	64	2-2362375-2
	2.30	36	2-2362375-1
15u"	2.30	164	1-2362375-4
	2.30	98	1-2362375-3
	2.30	64	1-2362375-2
	2.30	36	1-2362375-1
G/F	2.30	164	2362375-4
	2.30	98	2362375-3
	2.30	64	2362375-2
	2.30	36	2362375-1
GOLD PLATING	E	POS.	PART NUMBER

DATE CODE & P/N

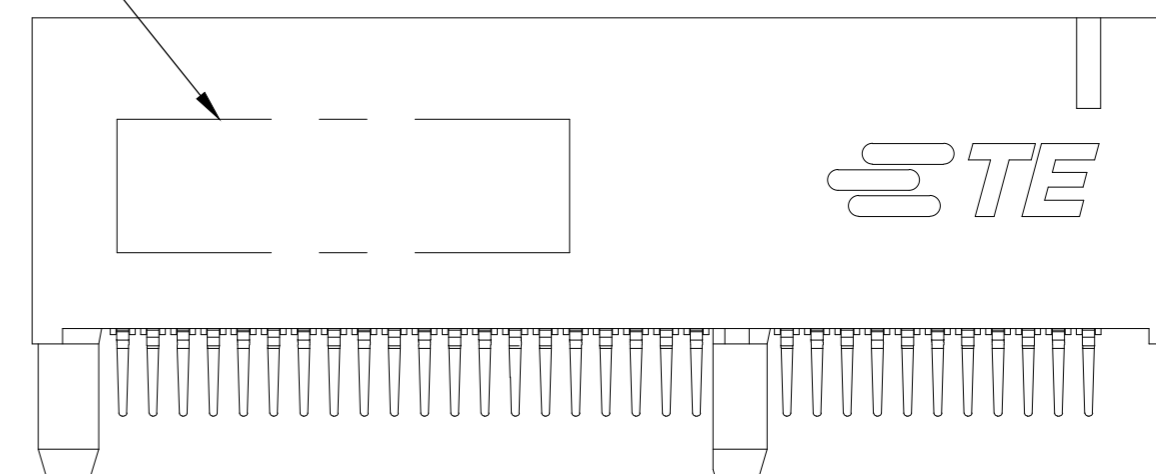

2362375

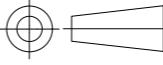
THIS DRAWING IS A CONTROLLED DOCUMENT.		DWN TONY LI 04SEP2019	 TE Connectivity Ltd.	
DIMENSIONS: mm		CHK SANDERS YAN 04SEP2019		
		APVD HOPE LU 04SEP2019 PRODUCT SPEC		NAME PCI EXPRESS CARD EDGE DIP TYPE GEN4 CONNECTOR
TOLERANCES UNLESS OTHERWISE SPECIFIED:		APPLICATION SPEC		RESTRICTED TO
0 PLC ± -		WEIGHT		SIZE A2
1 PLC ± -		CAGE CODE		00779
2 PLC ± -		DRAWING NO		C-2362375
3 PLC ± -		SCALE		4:1
4 PLC ± -		SHEET		2 of 4
ANGLES ± -		CUSTOMER DRAWING		REV A
FINISH		SCALE		4:1
MATERIAL		SHEET		2 of 4



REVISIONS					
P	LTR	DESCRIPTION	DATE	DWN	APVD
-	-	SEE SHEET 1	-	-	-

PRODUCT

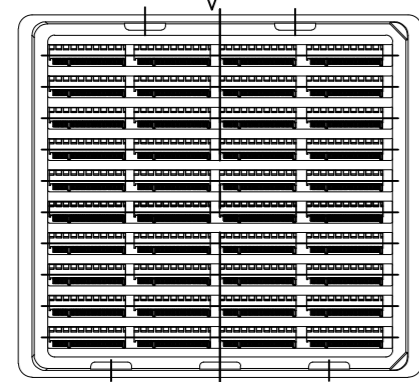

TRAY

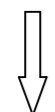

FIBER PAPER

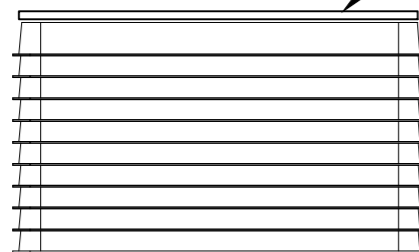

TRAY

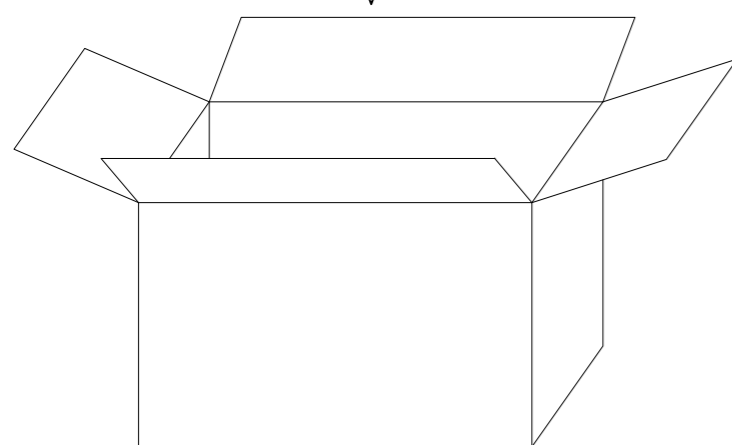

INNER BOX

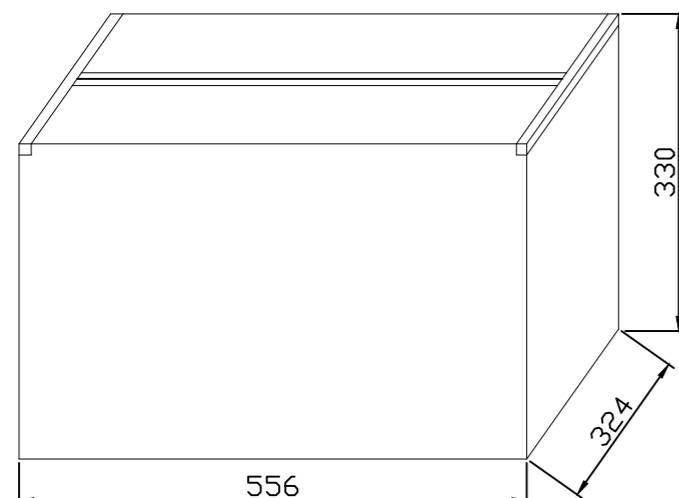
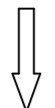

OUTER BOX

DRIER 4PCS(1g/PC)

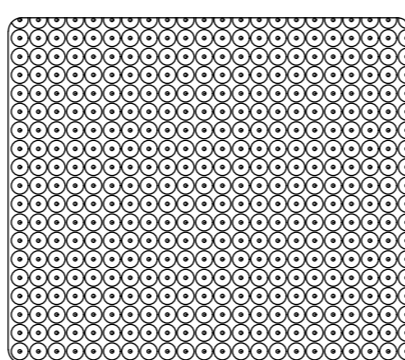
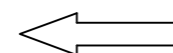
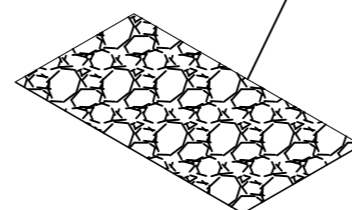

FOAM

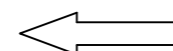

CODE	DESCRIPTION	PCS/TRAY	TRAY/INNER BOX	INNER BOX/OUTER BOX	PCS/OUTER BOX
4	X1	100	10	4	4000
3	X4	60	10	4	2400
2	X8	40	10	4	1600
1	X16	20	10	4	800
		QUANTITY		BOX	

THIS DRAWING IS A CONTROLLED DOCUMENT.

DWN	TONY LI	04SEP2019	 TE Connectivity Ltd.
CHK	SANDERS YAN	04SEP2019	
APVD	HOPE LU	04SEP2019	
PRODUCT SPEC	NAME		
APPLICATION SPEC	PCI EXPRESS CARD EDGE DIP TYPE GEN4 CONNECTOR		RESTRICTED TO
MATERIAL	FINISH	WEIGHT	0
CUSTOMER DRAWING		SCALE	4:1
		SHEET	4 OF 4
		REV	A