

Low Voltage Operation H-Bridge Driver

FEATURES

- Supply Voltage 1.8V to 5.5V
- Output Current 1500mA peak ($V_{DD}=5.0V$)
1200mA peak ($V_{DD}=3.0V$)
- Low Output ON Resistance $R_{O(H+L)}=0.23\Omega$ max. ($V_{DD}=5.0V$)
 $R_{O(H+L)}=0.27\Omega$ max. ($V_{DD}=3.0V$)
 $R_{O(H+L)}=0.37\Omega$ max. ($V_{DD}=1.8V$)
- Low Quiescent Current 100 μ A max. ($V_{DD}=3.0V$)
- Standby Current 100nA max.
- 2 Logic Inputs (2-IN) Control
- Protection Circuit UVLO, OCP, TSD
- Package MSOP8 (2.9×4.0×1.0mm)

GENERAL DESCRIPTION

The NJU7386 is a single H-bridge driver IC that features low voltage operation and low ON resistance. The control method is 2 logic Inputs (2-IN) that includes standby mode.

The NJU7386 provides low output ON resistance performance at supply voltage range adequately.

Therefore, it is suitable for high output drive of various small actuators ranging from two dry cell batteries to 5V power supply.

APPLICATIONS

- Portable Devices
- Haptics Devices
- Consumer Devices

Driving for DC motor, piezoelectric element, latching solenoid and latching relay.

BLOCK DIAGRAM

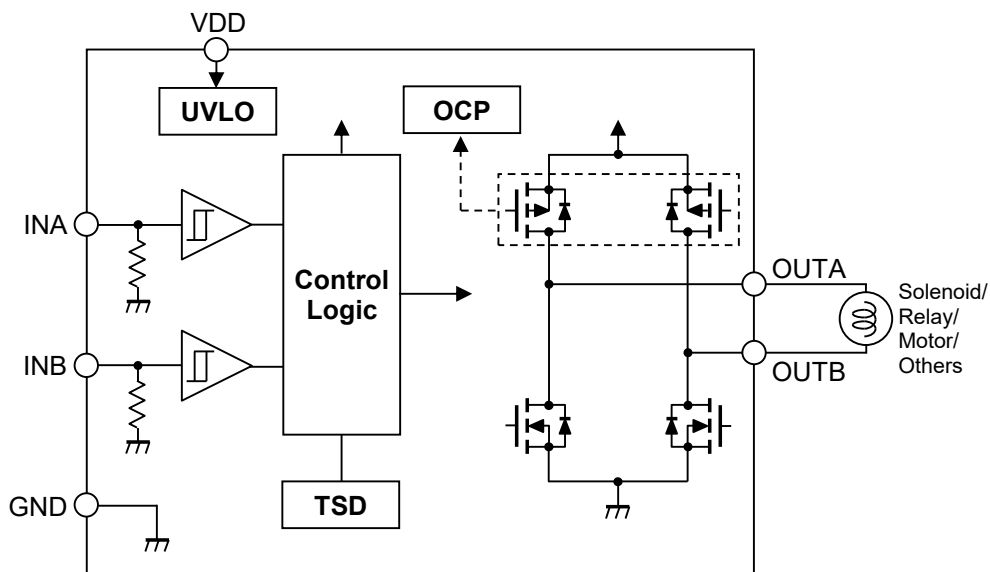

■PIN CONFIGURATION

MSOP8

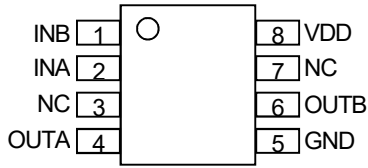

PIN NO.	SYMBOL	I/O	DESCRIPTION
1	INB	I	Input Pin B
2	INA	I	Input Pin A
3	NC	-	Not Internally Connected
4	OUTA	O	Output Pin A
5	GND	-	Ground
6	OUTB	O	Output Pin B
7	NC	-	Not Internally Connected
8	VDD	-	Power Supply Pin

■MARK INFORMATION

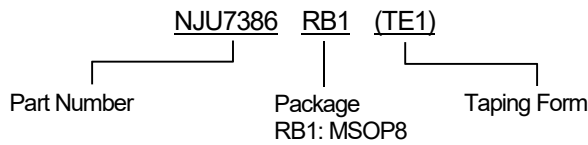

■ORDERING INFORMATION

PART NUMBER	PACKAGE OUTLINE	RoHS	HALOGEN-FREE	TERMINAL FINISH	MARKING	WEIGHT (mg)	MOQ(pcs)
NJU7386RB1	MSOP8	yes	yes	Sn2Bi	7386	18	2000

■ABSOLUTE MAXIMUM RATINGS

PARAMETER	SYMBOL	RATINGS	UNIT
Power Supply Pin Voltage	V_{DD}	7	V
Logic Input Pin Voltage	V_{IN}	7	V
Output Pin Current	I_{OPEAK}	Internal Limited	mA
Power Dissipation ($T_a=25^\circ\text{C}$)	P_D	MSOP8	590 ⁽¹⁾
			810 ⁽²⁾
Junction Temperature	T_j	-40 to +150	$^\circ\text{C}$
Operating Temperature	T_{opr}	-40 to +125	$^\circ\text{C}$
Storage Temperature	T_{stg}	-50 to +150	$^\circ\text{C}$

(1): Mounted on glass epoxy board. (76.2×114.3×1.6mm: based on EIA/JEDEC standard, 2Layers FR-4)

(2): Mounted on glass epoxy board. (76.2×114.3×1.6mm: based on EIA/JEDEC standard, 4Layers FR-4, inner Cu area 74.2×74.2mm)

■RECOMMENDED OPERATING CONDITIONS

PARAMETER	SYMBOL	RATINGS	UNIT
Power Supply Pin Voltage	V_{DD}	1.8 to 5.5	V

■ ELECTRICAL CHARACTERISTICS

 (Unless other noted, $V_{DD}=3V$, $T_a=25^\circ C$)

PARAMETER	SYMBOL	TEST CONDITION	MIN.	TYP.	MAX.	UNIT
GENERAL						
Quiescent Current	I_{DD}	Except I_{IH}	-	60	100	μA
Quiescent Current at Standby	I_{STB}		-	-	100	nA
UNDER VOLTAGE LOCKOUT BLOCK						
UVLO Operating Voltage	V_{DUVLO}		1.1	1.4	-	V
UVLO Recovery Voltage	V_{RUVLO}		-	1.5	1.8	V
UVLO Hysteresis Voltage	ΔV_{UVLO}		-	0.1	-	V
THERMAL SHUTDOWN BLOCK						
Thermal Shutdown Operating Temperature	T_{TSD1}		-	170	-	$^\circ C$
Thermal Shutdown Recovery Temperature	T_{TSD2}		-	150	-	$^\circ C$
Thermal Shutdown Hysteresis	ΔT_{TSD}		-	20	-	$^\circ C$
LOGIC BLOCK						
H Level Input Voltage 1	V_{IH1}		2.0	-	-	V
H Level Input Voltage 2	V_{IH2}	$V_{DD}=1.8V$	1.4	-	-	V
L Level Input Voltage 1	V_{IL1}		0	-	0.8	V
L Level Input Voltage 2	V_{IL2}	$V_{DD}=1.8V$	0	-	0.4	V
Input Hysteresis Width	ΔV_{IHYS}		-	0.2	-	V
H Level Input Current	I_{IH}	Per 1 Input	20	30	50	μA
L Level Input Current	I_{IL}	Per 1 Input	-	-	50	nA
Input Pull Down Resistance	R_{IN}		60	100	150	k Ω
Input Pulse Width	t_p		1	-	-	μs
DRIVER BLOCK						
Output ON Resistance 1	R_{ON1}	$V_{DD}=5V$, $I_O=400mA$, H+L sides	-	0.18	0.23	Ω
Output ON Resistance 2	R_{ON2}	$I_O=400mA$, H+L sides	-	0.22	0.27	Ω
Output ON Resistance 3	R_{ON3}	$V_{DD}=1.8V$, $I_O=400mA$, H+L sides	-	0.30	0.37	Ω
R_{ONH} Temperature Coefficient	$\Delta R_{ONH}/\Delta T_j$	$T_j=-40$ to $150^\circ C$, $I_O=400mA$	-	0.33	-	m $\Omega/^\circ C$
R_{ONL} Temperature Coefficient	$\Delta R_{ONL}/\Delta T_j$	$T_j=-40$ to $150^\circ C$, $I_O=400mA$	-	0.33	-	m $\Omega/^\circ C$
High Side Reverse Voltage	V_{ORH}	$I_O=-400mA$	-	0.7	0.9	V
Low Side Reverse Voltage	V_{ORL}	$I_O=-400mA$	-	0.7	0.9	V
High Side Leak Current	I_{OLEAKH}	$V_{DD}=5.5V$, $V_O=0V$	-	-	200	nA
Low Side Leak Current	I_{OLEAKL}	$V_{DD}=5.5V$, $V_O=5.5V$	-	-	200	nA
Output Turn ON Time	t_{ON}		50	115	180	ns
Output Turn OFF Time	t_{OFF}		5	25	45	ns
Dead Time	t_d		45	90	135	ns
OCP Detection Current 1	I_{OCP1}		1.2	2.7	-	A
OCP Detection Current 2	I_{OCP2}	$V_{DD}=5V$	1.5	3.2	-	A
OCP Recovery Time	t_{REOCP}		-	1	-	ms
Blanking Time	t_B		-	500	-	ns

■ THERMAL CHARACTERISTICS

PARAMETER	SYMBOL	VALUE	UNIT
Junction-to-ambient thermal resistance	θ_{ja}	213 ⁽³⁾	°C/W
		155 ⁽⁴⁾	
Junction-to-Top of package characterization parameter	ψ_{jt}	28 ⁽³⁾	°C/W
		25 ⁽⁴⁾	

(3): Mounted on glass epoxy board. (76.2×114.3×1.6mm: based on EIA/JEDEC standard, 2Layers FR-4)

(4): Mounted on glass epoxy board. (76.2×114.3×1.6mm: based on EIA/JEDEC standard, 4Layers FR-4, inner Cu area 74.2×74.2mm)

■ POWER DISSIPATION vs. AMBIENT TEMPERATURE

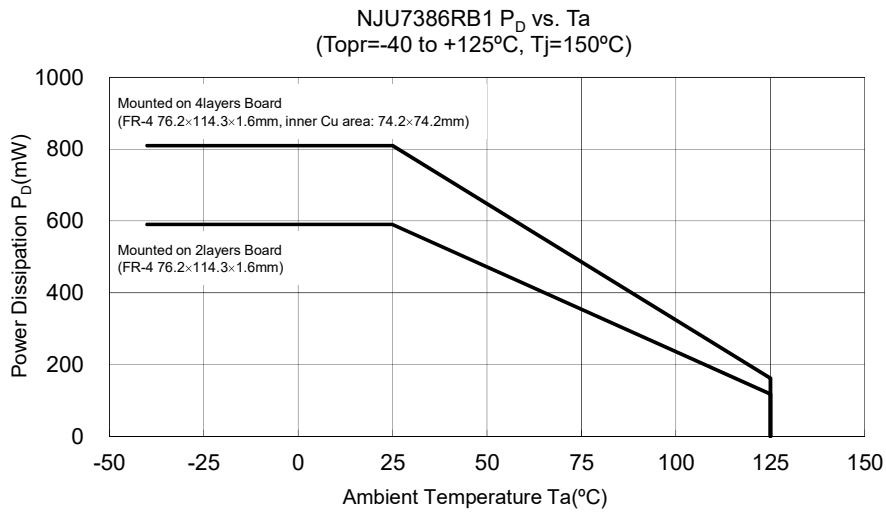

■ INPUT - OUTPUT TRUTH TABLE

INPUT (L=Low/Open, H=High, X=Don't care)		OUTPUT (H=Source, L=Sink, OFF=Hi-Z)		STATUS
INA	INB	OUTA	OUTB	
L	L	OFF		Standby(Fast Decay)
H	L	H	L	CW
L	H	L	H	CCW
H	H	H	H	Brake(Slow Decay)
X		OFF		UVLO, OCP, TSD

■ INPUT - OUTPUT TIMING CHART

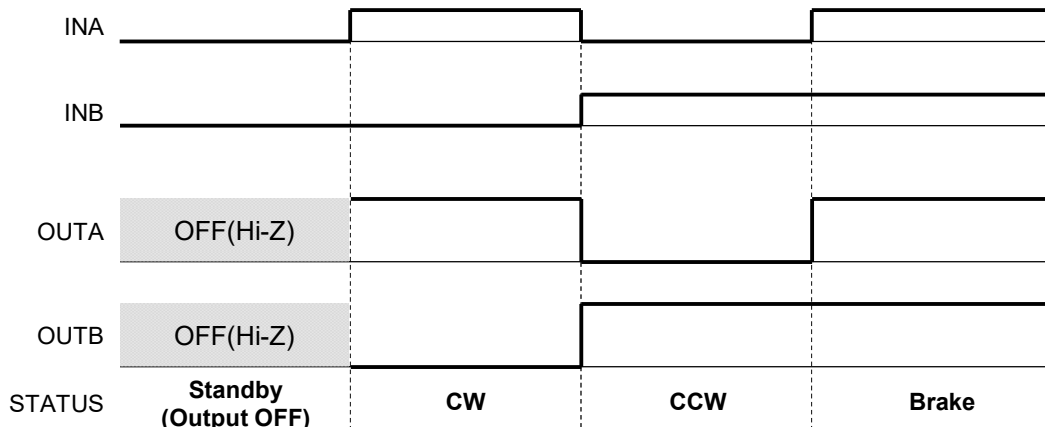

APPLICATION NOTE / GLOSSARY

Pin, Circuit Operation Definition

<INA, INB pin>

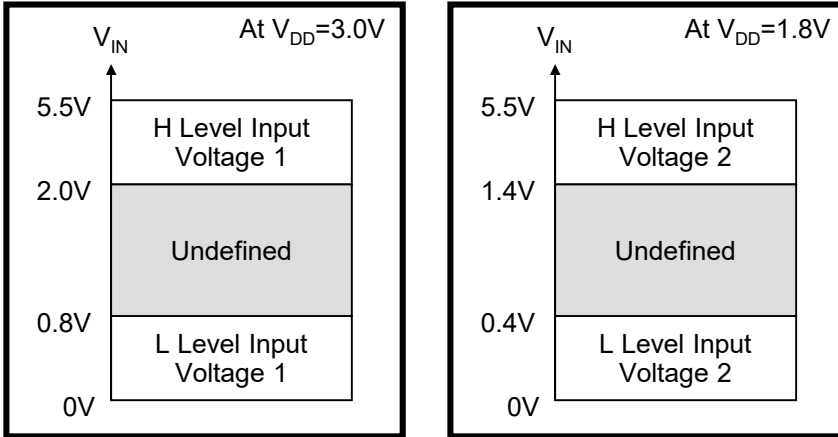

The H / L level threshold voltage varies depending on the power supply pin voltage V_{DD} . Further, The INA and INB pins correspond to input tolerant.

<Input - Output Timing Definition>

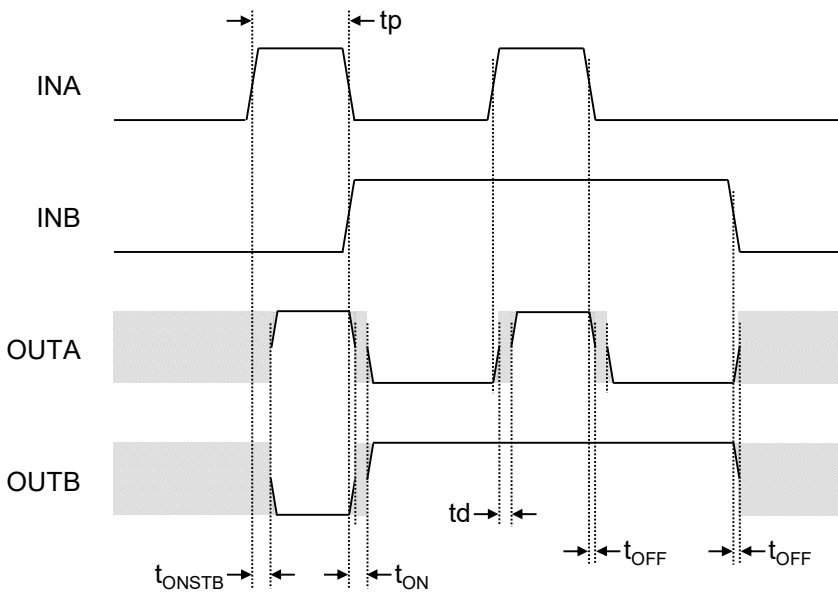

PARAMETER	SYMBOL
Input Pulse Width (Minimum Input Pulse Width)	t_p
Output Turn ON Time at Standby	t_{ONSTB}
Output Turn ON Time	t_{ON}
Output Turn OFF Time	t_{OFF}
Dead Time ($t_{ON}-t_{OFF}$)	t_d

Hi-Z

<Standby Function>

When the time of $INA=L$ and $INB=L$ exceeds approximately $4\mu s$ typ., it becomes the standby state and all protection functions are reset.

Further, the turn on time from the standby state is defined as t_{ONSTB} .

PARAMETER	SYMBOL	TYPICAL VALUE			UNIT
		$V_{DD}=5.0V$	$V_{DD}=3.0V$	$V_{DD}=1.8V$	
Output Turn ON Time at Standby	t_{ONSTB}	70	120	360	ns

<Under Voltage Lockout (UVLO) Operating Voltage>

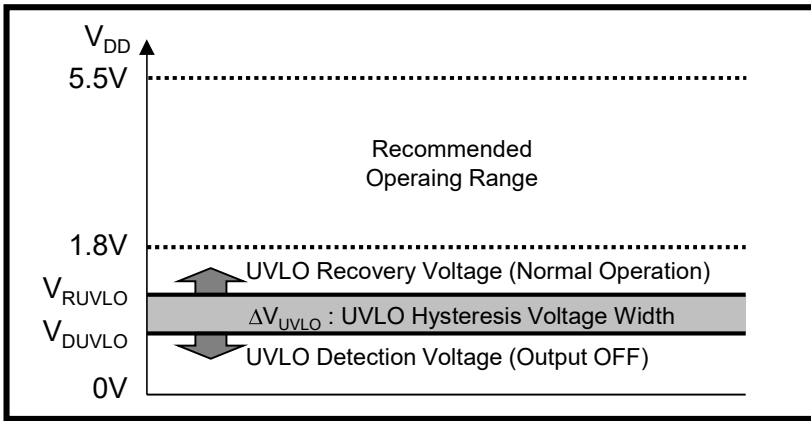

When the power supply pin voltage V_{DD} is less than the UVLO detection voltage, the output pins are turned off.
 When the power supply pin voltage V_{DD} is over than the UVLO recovery voltage, it becomes to normal operation.

<Thermal Shutdown (TSD) Operating Temperature>

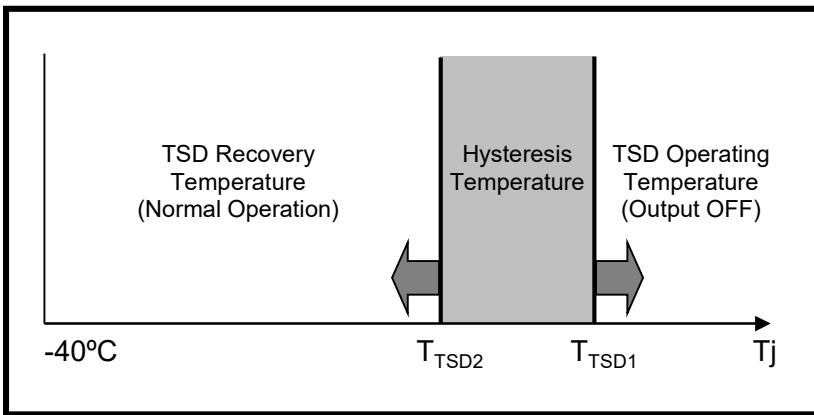

When the junction temperature T_j is over than T_{TSD1} , the thermal shutdown circuit operates and the output pins are turned off.
 When the junction temperature T_j is less than T_{TSD2} , normal operation resumes.

<Over Current Protection (OCP) Timing Chart>

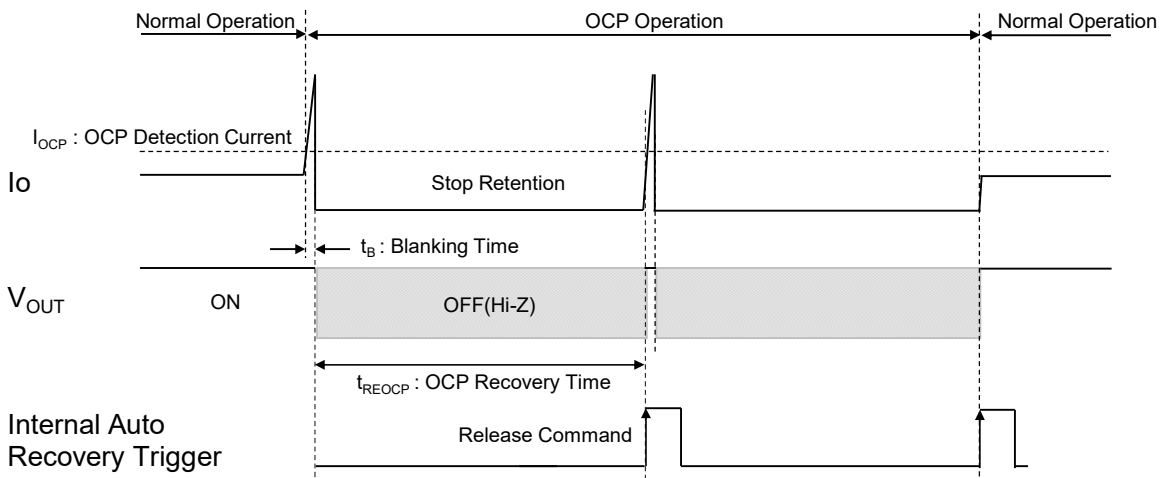

The OCP function detects the overcurrent of the output pins.
 If the output current over I_{OCP} flows to continue more than t_b time, the OCP operates and the output pins are turned off.
 In the OCP state, the output pins automatically resume after the OCP recovery time t_{REOCP} .

•Typical Application

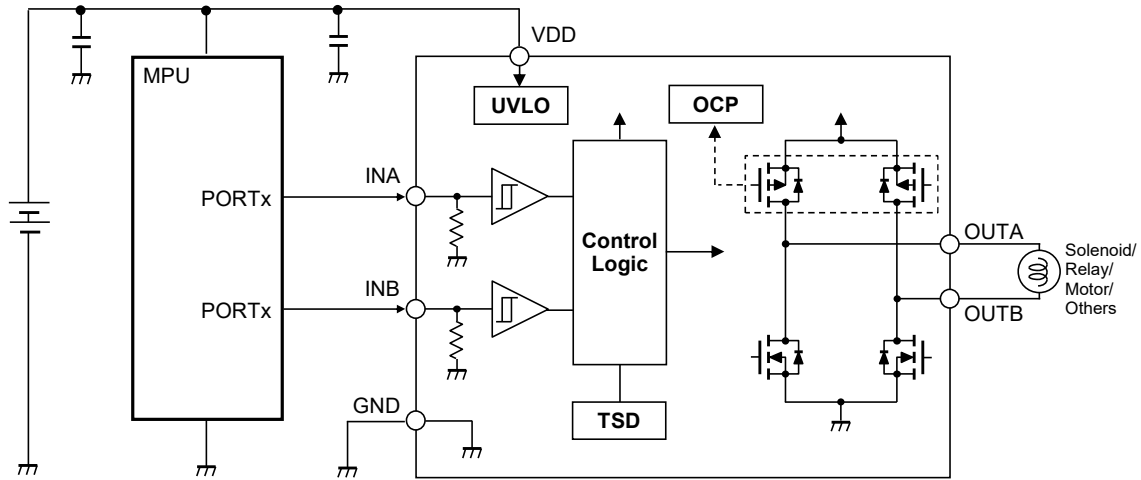

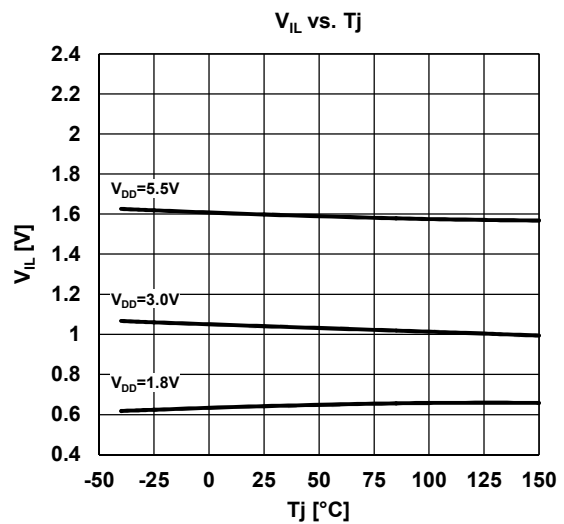
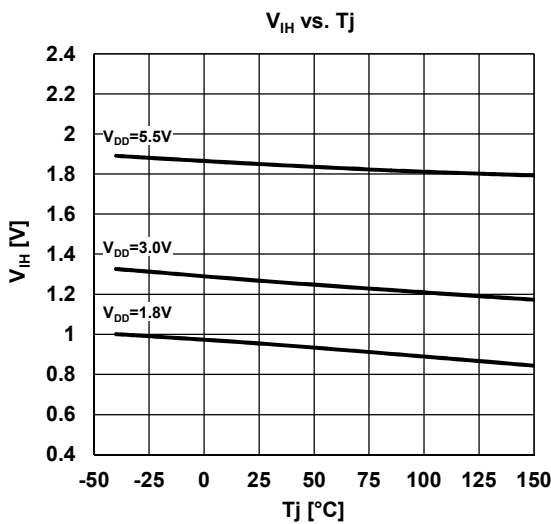
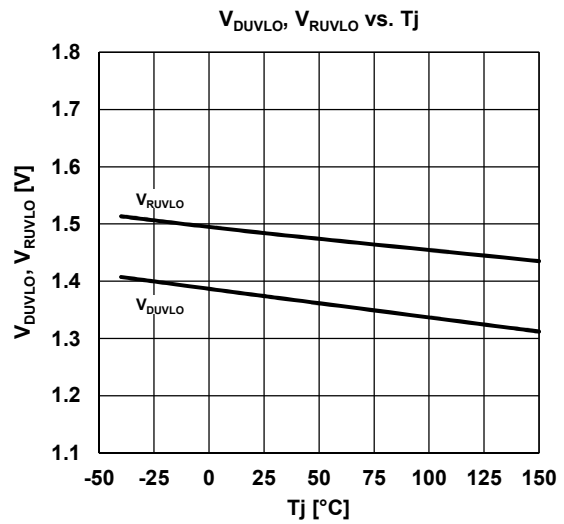
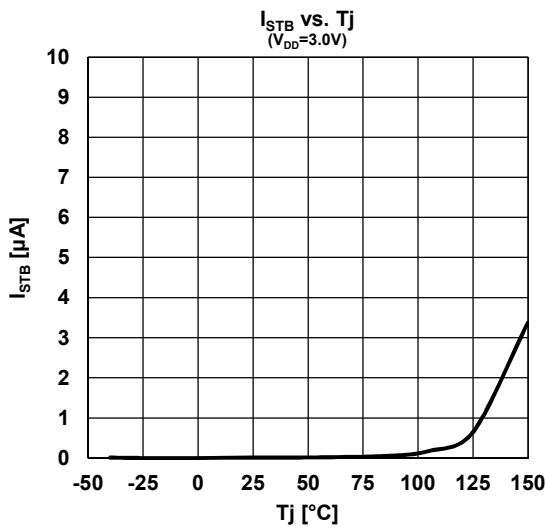
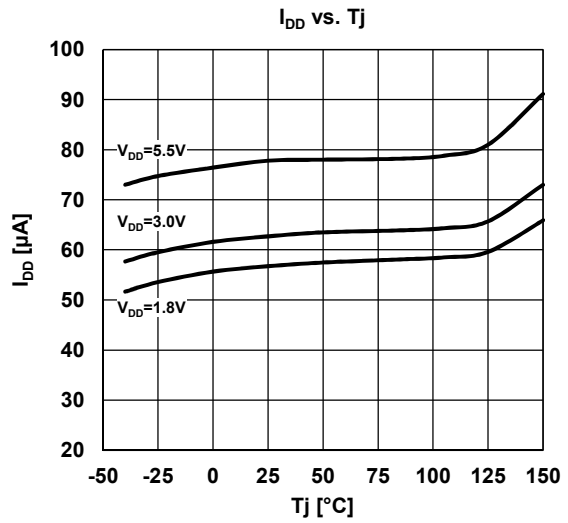
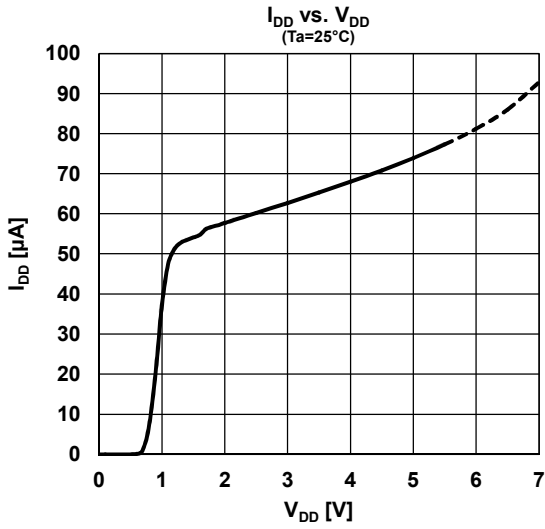
■ TYPICAL CHARACTERISTICS

TYPICAL CHARACTERISTICS

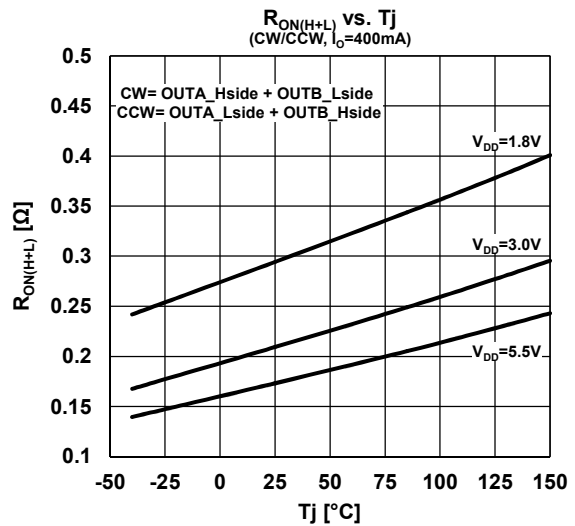
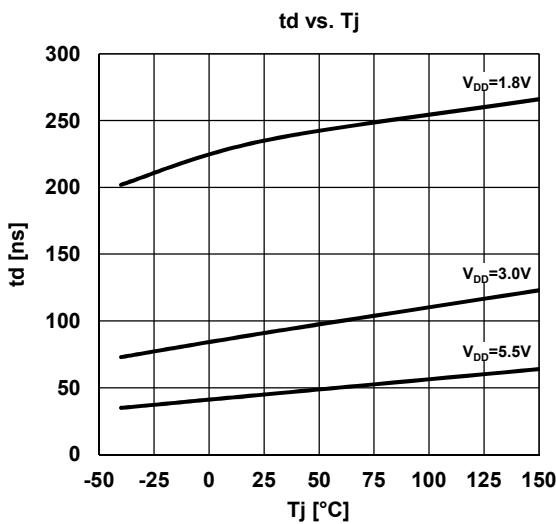
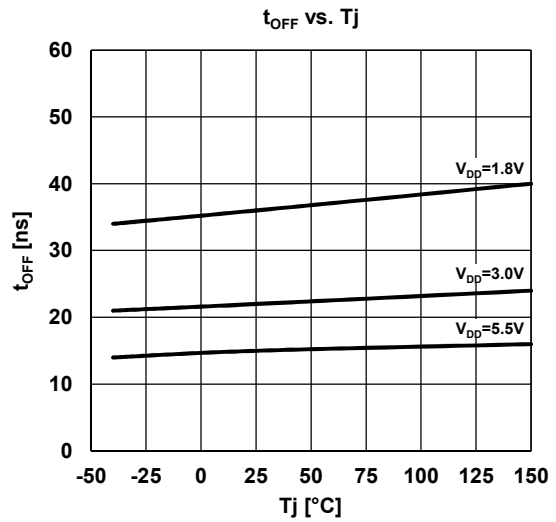
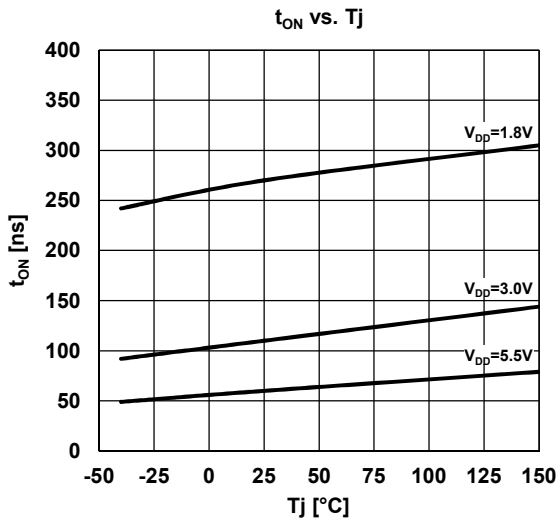
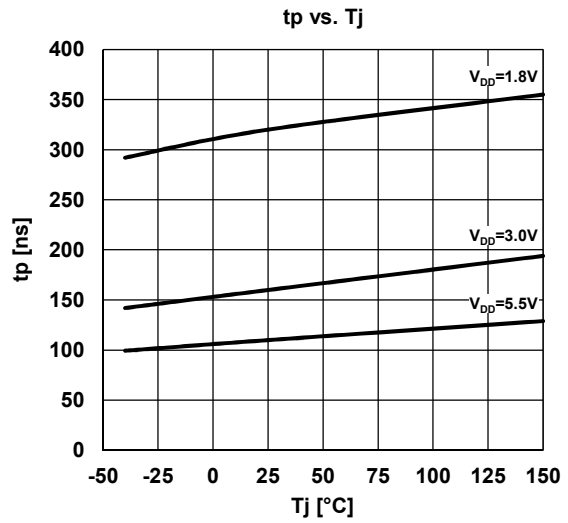
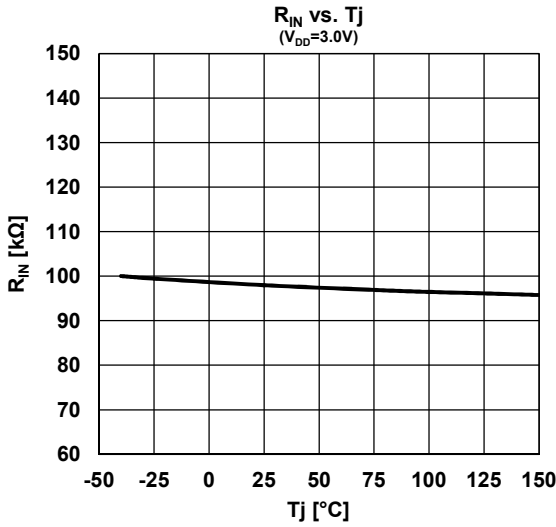

■ TYPICAL CHARACTERISTICS

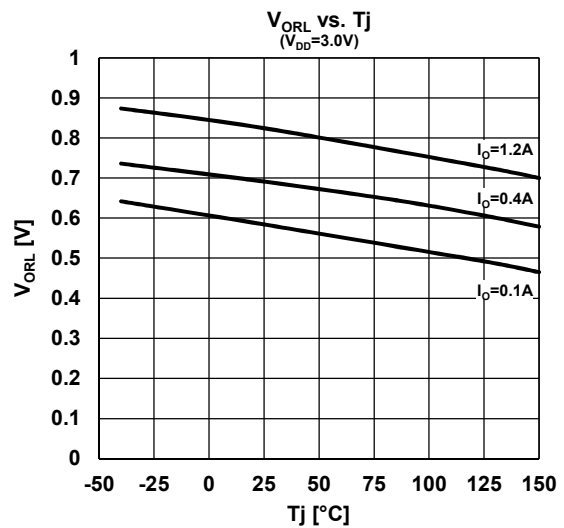
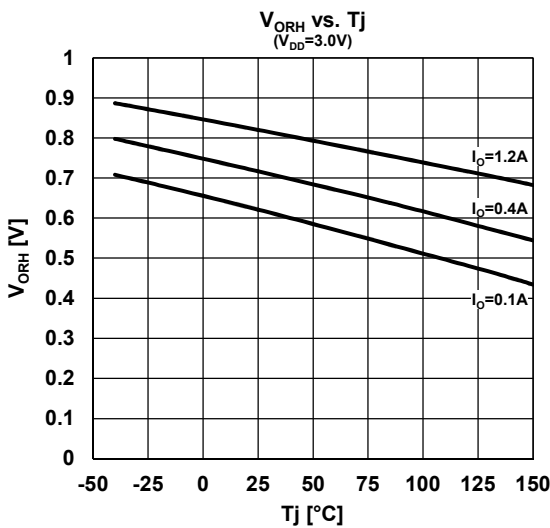
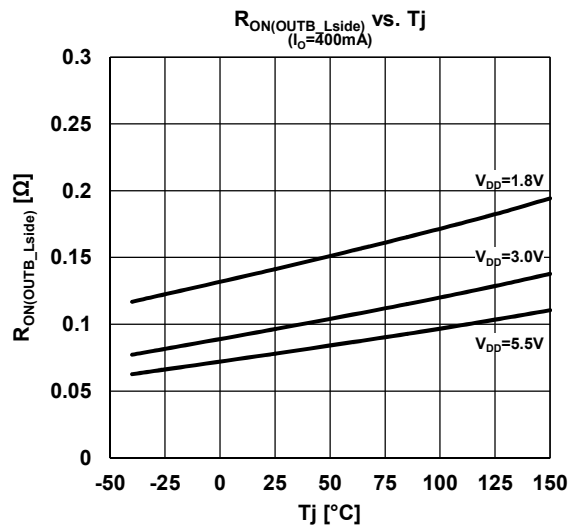
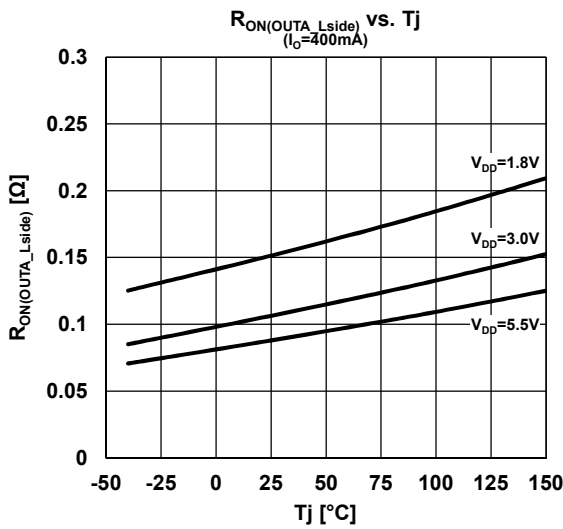
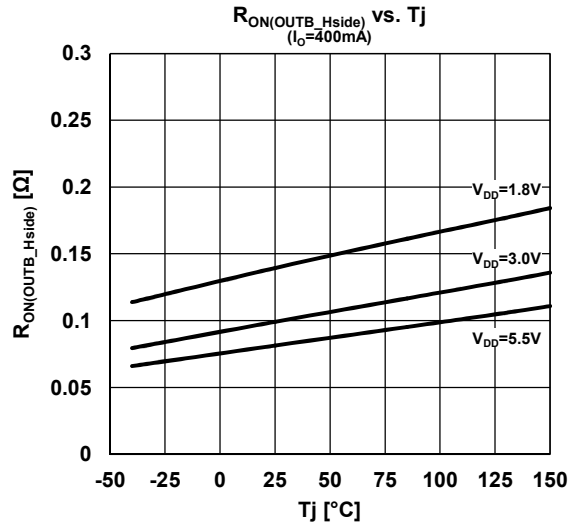
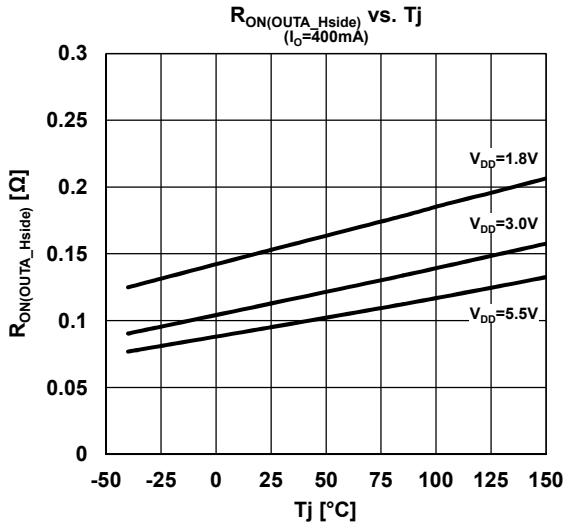

■ TYPICAL CHARACTERISTICS

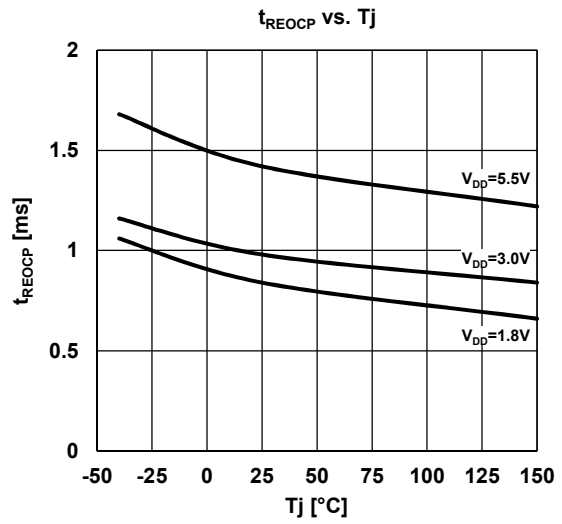
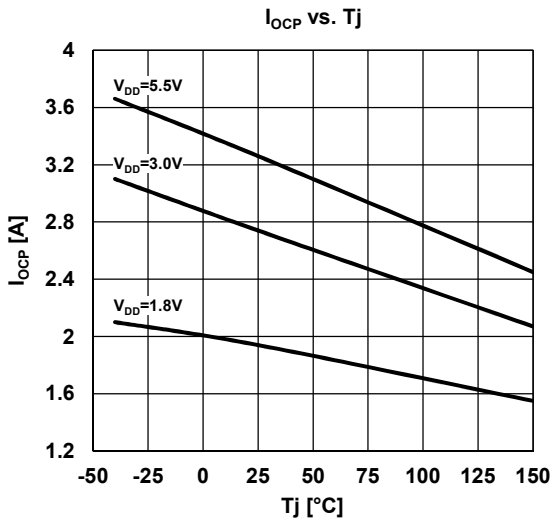
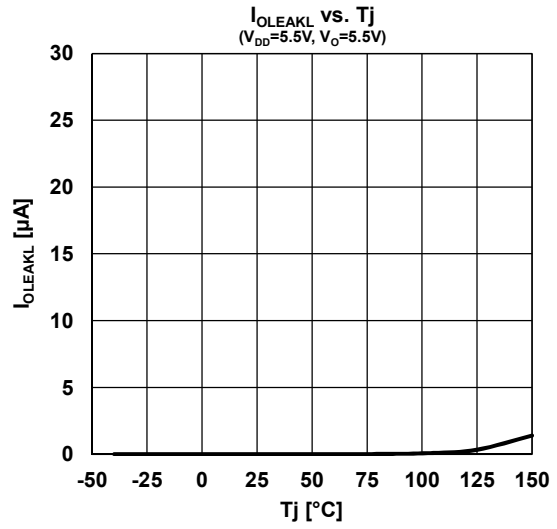
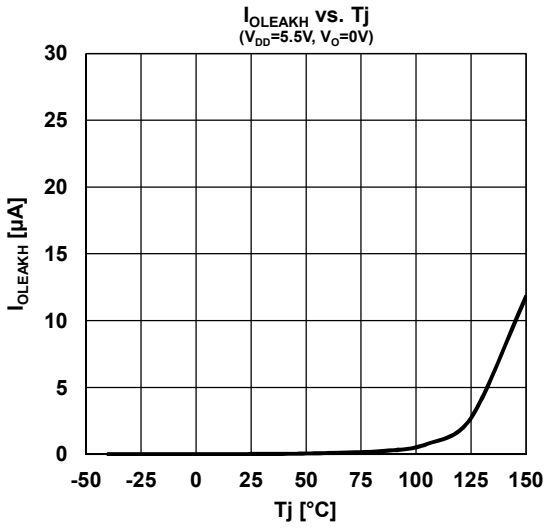

MSOP8 JEDEC MO-187-DA/THIN TYPE

Unit: mm

PACKAGE DIMENSIONS

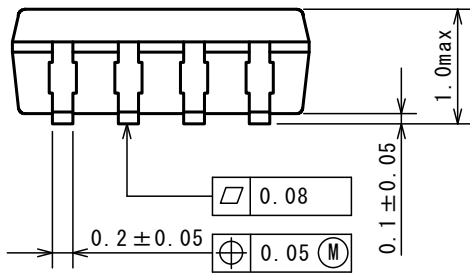
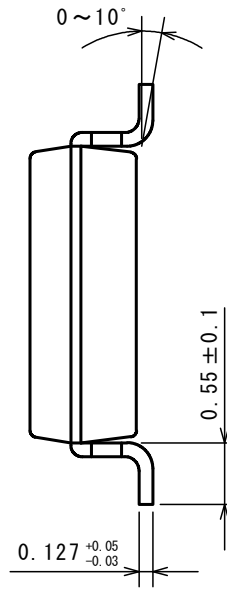
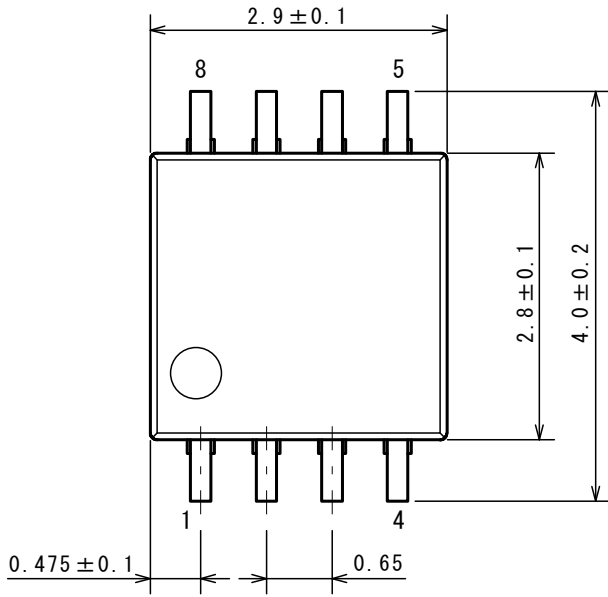

EXAMPLE OF SOLDER PADS DIMENSIONS

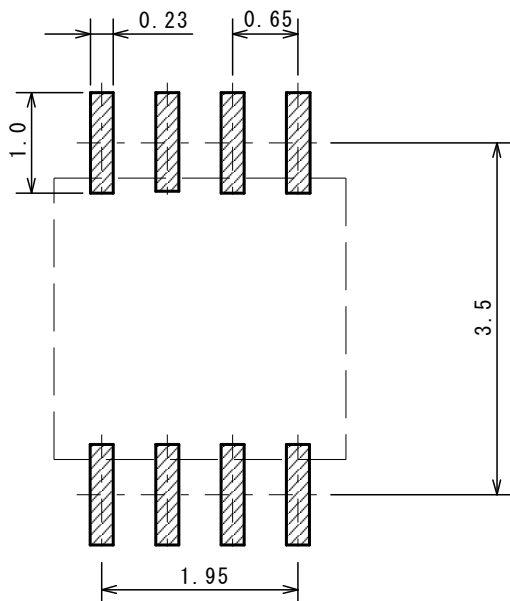

Unit: mm

PACKING SPEC

TAPING DIMENSIONS

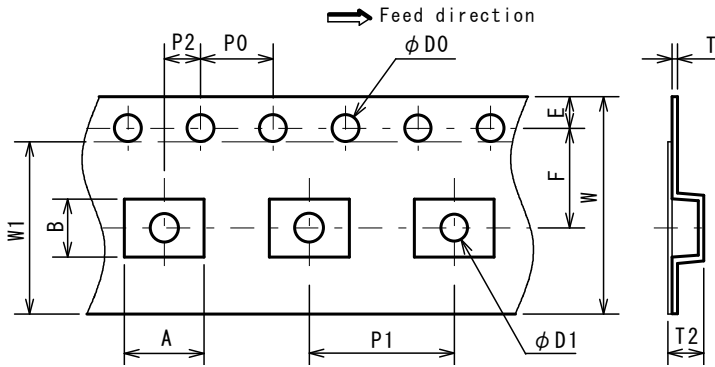

SYMBOL	DIMENSION	REMARKS
A	4.4	BOTTOM DIMENSION
B	3.2	BOTTOM DIMENSION
D0	1.5 ^{+0.1} ₀	
D1	1.5 ^{+0.1} ₀	
E	1.75±0.1	
F	5.5±0.05	
P0	4.0±0.1	
P1	8.0±0.1	
P2	2.0±0.05	
T	0.30±0.05	
T2	1.75 (MAX.)	
W	12.0±0.3	
W1	9.5	THICKNESS 0.1max

REEL DIMENSIONS

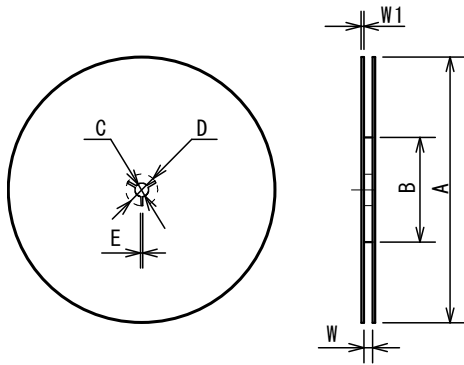

SYMBOL	DIMENSION
A	φ 254±2
B	φ 100±1
C	φ 13±0.2
D	φ 21±0.8
E	2±0.5
W	13.5±0.5
W1	2.0±0.2

TAPING STATE

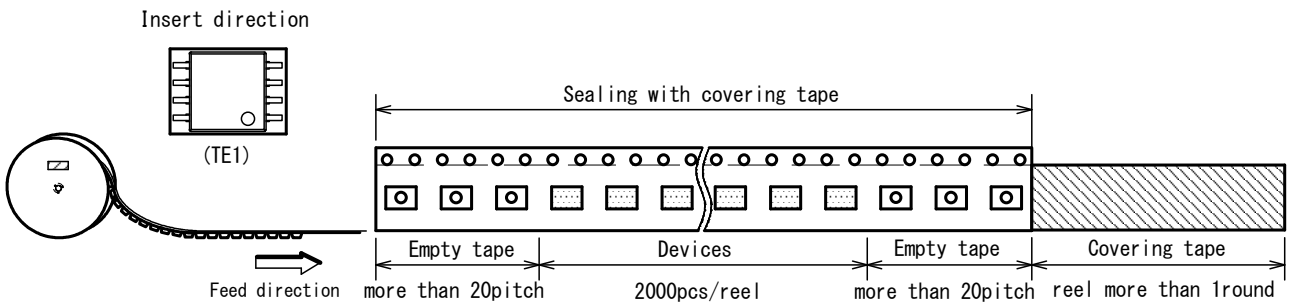

PACKING STATE

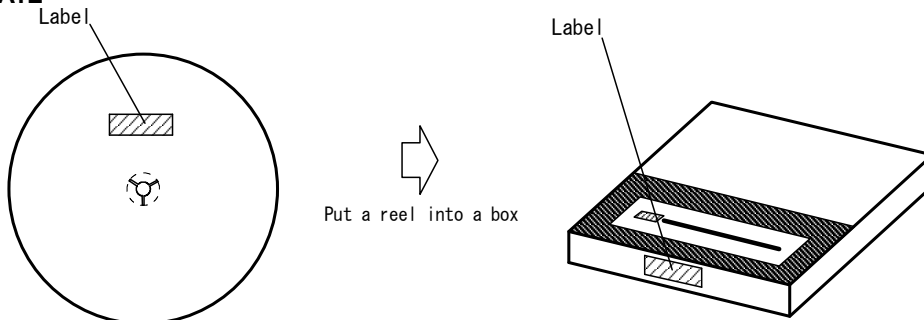

RECOMMENDED MOUNTING METHOD
INFRARED REFLOW SOLDERING METHOD

*Recommended reflow soldering procedure

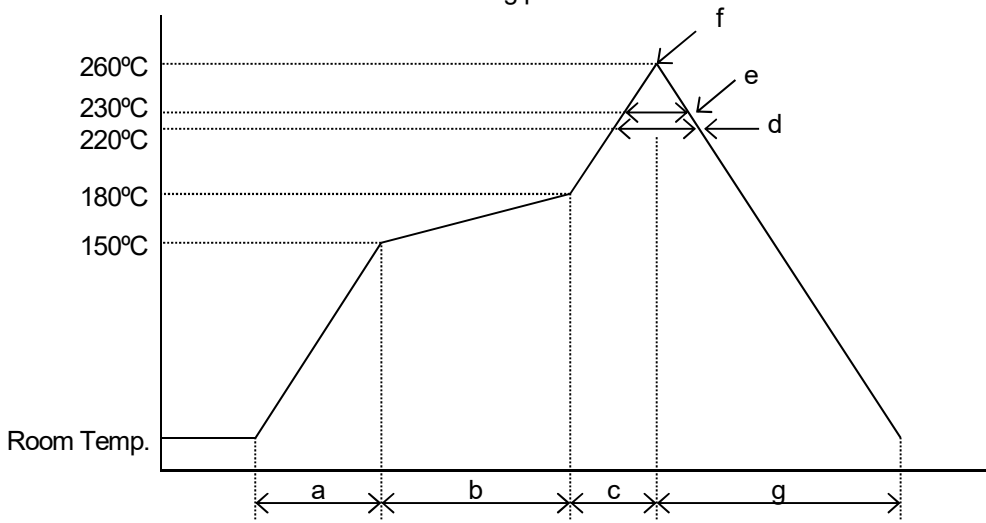

- a: Temperature ramping rate : 1 to 4°C/s
- b: Pre-heating temperature : 150 to 180°C
- Pre-heating time : 60 to 120s
- c: Temperature ramp rate : 1 to 4°C/s
- d: 220°C or higher time : Shorter than 60s
- e: 230°C or higher time : Shorter than 40s
- f: Peak temperature : Lower than 260°C
- g: Temperature ramping rate : 1 to 6°C/s

The temperature indicates at the surface of mold package.

FLOW SOLDERING METHOD

*Recommended flow soldering procedure

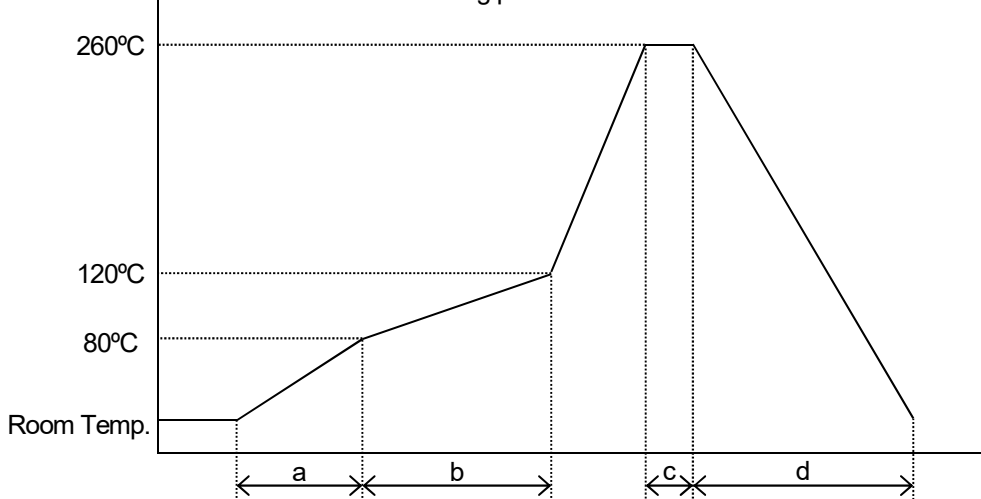

- a: Temperature ramping rate : 1 to 7 °C/s
- b: Pre-heating temperature : 80 to 120 °C
- Pre-heating time : 60 to 120s
- c: Peak temperature : not exceeding 260 °C
- Peak time : within 10s
- d: Temperature ramping rate : 1 to 7 °C/s

The temperature indicates at the surface of mold package.

■REVISION HISTORY

Date	Revision	Changes
04.Mar.2019	Ver.1.0	New Release

[CAUTION]

1. NJR strives to produce reliable and high quality semiconductors. NJR's semiconductors are intended for specific applications and require proper maintenance and handling. To enhance the performance and service of NJR's semiconductors, the devices, machinery or equipment into which they are integrated should undergo preventative maintenance and inspection at regularly scheduled intervals. Failure to properly maintain equipment and machinery incorporating these products can result in catastrophic system failures
2. The specifications on this datasheet are only given for information without any guarantee as regards either mistakes or omissions. The application circuits in this datasheet are described only to show representative usages of the product and not intended for the guarantee or permission of any right including the industrial property rights.
All other trademarks mentioned herein are the property of their respective companies.
3. To ensure the highest levels of reliability, NJR products must always be properly handled.
The introduction of external contaminants (e.g. dust, oil or cosmetics) can result in failures of semiconductor products.
4. NJR offers a variety of semiconductor products intended for particular applications. It is important that you select the proper component for your intended application. You may contact NJR's Sale's Office if you are uncertain about the products listed in this datasheet.
5. Special care is required in designing devices, machinery or equipment which demand high levels of reliability. This is particularly important when designing critical components or systems whose failure can foreseeably result in situations that could adversely affect health or safety. In designing such critical devices, equipment or machinery, careful consideration should be given to amongst other things, their safety design, fail-safe design, back-up and redundancy systems, and diffusion design.
6. The products listed in this datasheet may not be appropriate for use in certain equipment where reliability is critical or where the products may be subjected to extreme conditions. You should consult our sales office before using the products in any of the following types of equipment.
 - Aerospace Equipment
 - Equipment Used in the Deep Sea
 - Power Generator Control Equipment (Nuclear, steam, hydraulic, etc.)
 - Life Maintenance Medical Equipment
 - Fire Alarms / Intruder Detectors
 - Vehicle Control Equipment (Airplane, railroad, ship, etc.)
 - Various Safety Devices
7. NJR's products have been designed and tested to function within controlled environmental conditions. Do not use products under conditions that deviate from methods or applications specified in this datasheet. Failure to employ the products in the proper applications can lead to deterioration, destruction or failure of the products. NJR shall not be responsible for any bodily injury, fires or accident, property damage or any consequential damages resulting from misuse or misapplication of the products. The products are sold without warranty of any kind, either express or implied, including but not limited to any implied warranty of merchantability or fitness for a particular purpose.
8. Warning for handling Gallium and Arsenic (GaAs) Products (Applying to GaAs MMIC, Photo Reflector). These products use Gallium (Ga) and Arsenic (As) which are specified as poisonous chemicals by law. For the prevention of a hazard, do not burn, destroy, or process chemically to make them as gas or power. When the product is disposed of, please follow the related regulation and do not mix this with general industrial waste or household waste.
9. The product specifications and descriptions listed in this datasheet are subject to change at any time, without notice.

