

## CSPB40K-HF

Reverse Voltage: 800 Volts

Forward Current: 4.0 A

RoHS Device

Halogen Free

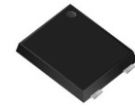

### Features

- Planar passivated chips.
- Ultra low leakage reverse current.
- High temperature performance.
- High surge current capability.
- Ideal for printed circuit boards.
- High temperature soldering guaranteed: 260°C/10 seconds.

### Mechanical data

- Case: SPB molded plastic.
- Molding compound, UL flammability classification rating 94V-0.
- Terminals: Leads solderable per MIL-STD-750,
- Mounting position: Any.

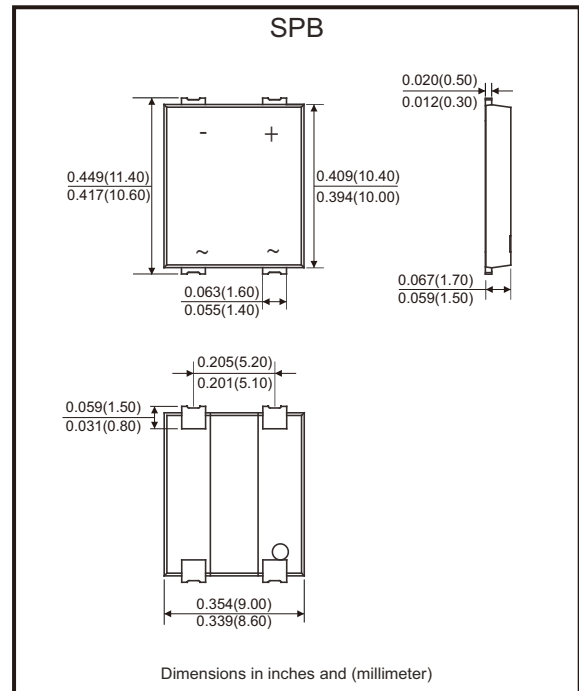

### Circuit diagram

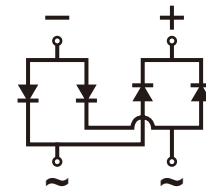

### Maximum Ratings (at Ta=25 °C unless otherwise specified)

Characteristic	Symbol	CSPB40K-HF	Units
Peak repetitive reverse voltage	$V_{RRM}$	800	V
RMS reverse voltage	$V_{RMS}$	560	V
DC blocking voltage	$V_{DC}$	800	V
Maximum average forward output current	$I_{F(AV)}$	4	A
Peak forward surge current, 8.3ms single half-sine-wave	@T <sub>J</sub> =25°C $I_{FSM}$	135	A
I <sup>2</sup> t rating for fusing	@T <sub>J</sub> =25°C $I^2t$	76	A <sup>2</sup> s

### Thermal Characteristics

Characteristic	Symbol	CSPB40K-HF	Units
Typical thermal resistance per leg (Note 1)	$R_{\theta JA}$	38	°C/W
	$R_{\theta JC}$	10.4	
	$R_{\theta JL}$	7.5	
Operating junction temperature range	$T_J$	-55 ~ +150	°C
Storage temperature range	$T_{STG}$	-55 ~ +150	°C

Note: 1. Device mounted on PCB with 10mm x 20mm x 0.1mm copper pad areas.

## Electrical Characteristics (at Ta=25 °C unless otherwise specified)

Parameter	Symbol	Test conditions	Typ.	Max.	Units	
Max. instantaneous forward voltage	V <sub>F</sub>	I <sub>F</sub> = 2.0A Per diode	0.91	0.95	V	
		I <sub>F</sub> = 4.0A Per diode	0.95	1.0		
Max. reverse current	I <sub>R</sub>	Rated V <sub>R</sub> , Per diode	@T <sub>A</sub> =25°C	0.5	1.0	μA
			@T <sub>A</sub> =150°C	40	100	

## Rating and Characteristic Curves (CSPB40K-HF)

Fig.1 - Forward Current Derating Curve

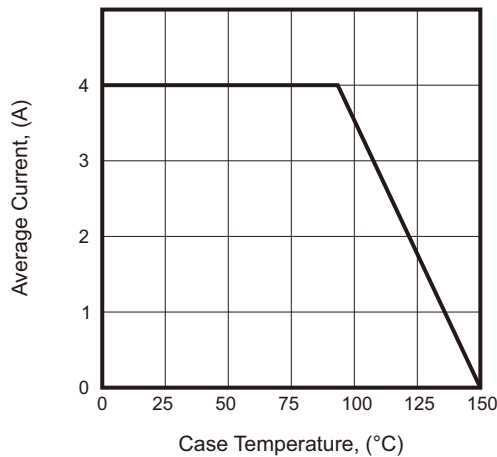

Fig.2 - Surge Current Derating Curve

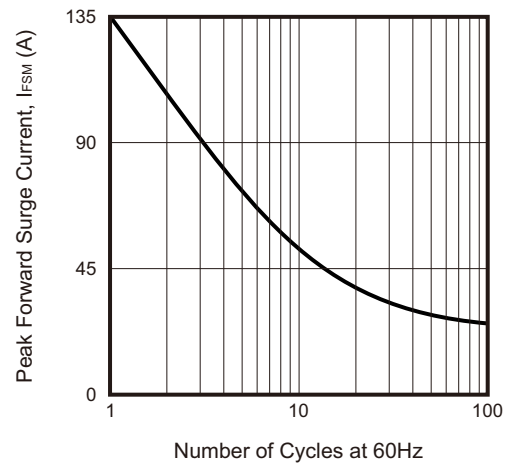

Fig.3 - Typical Forward Voltage Characteristic

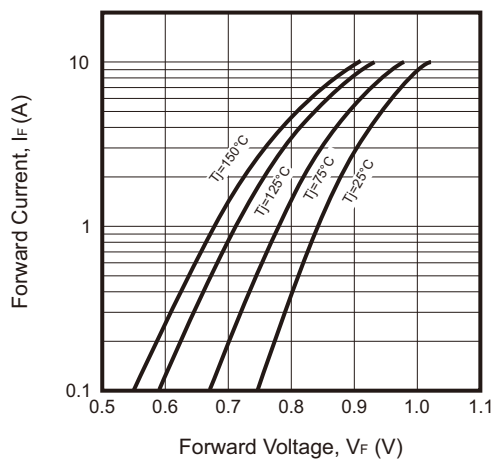
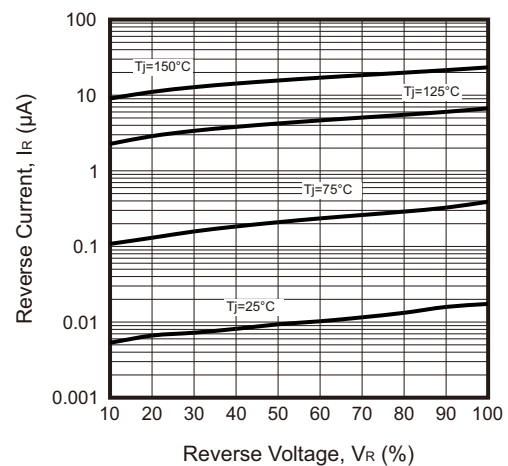
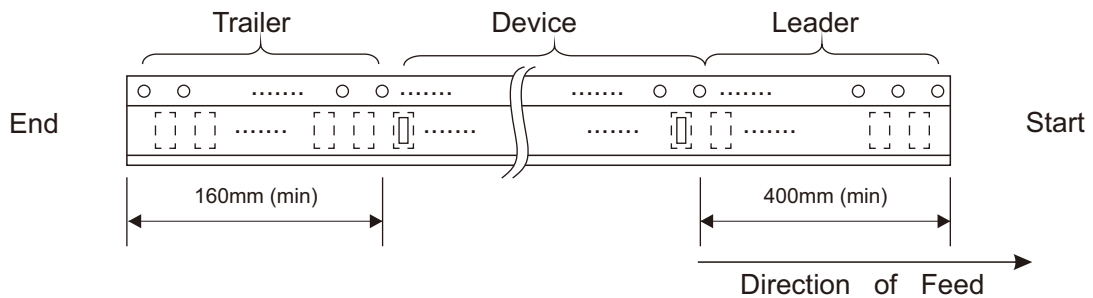
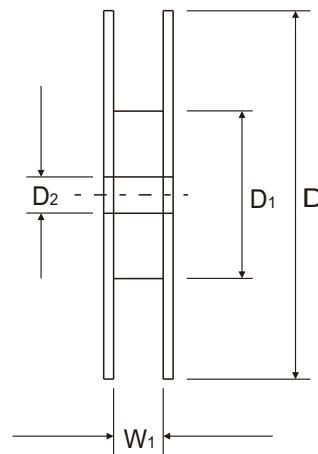
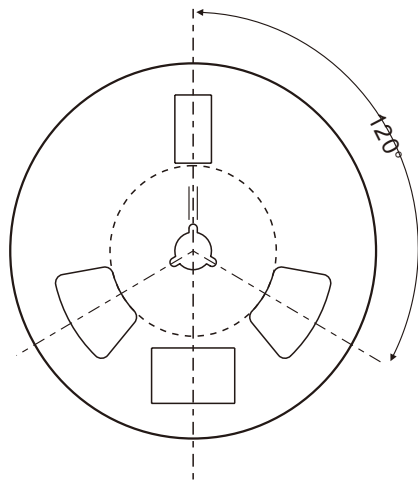
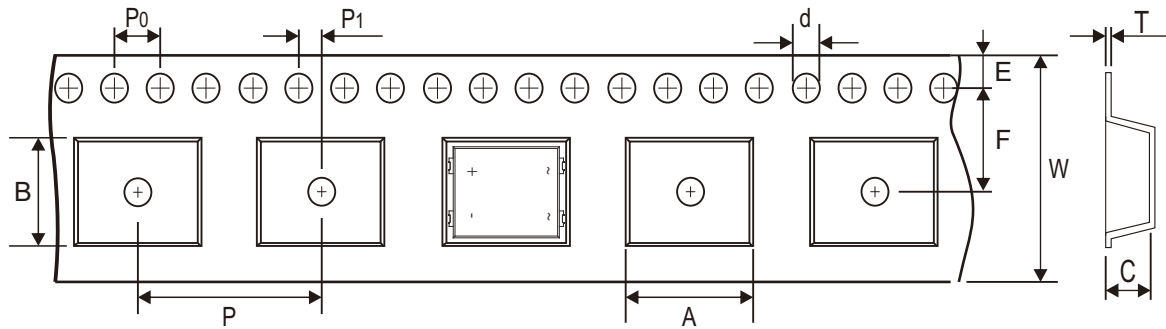

Fig.4 - Typical Reverse Characteristic



## Reel Taping Specification



SPB	SYMBOL	A	B	C	d	D	D1	D2
	(mm)	11.30 ± 0.10	9.00 ± 0.10	1.80 ± 0.10	1.50 ± 0.10	330.00 ± 1.00	75.00 ± 1.00	13.50 ± 0.05
	(inch)	0.445 ± 0.004	0.354 ± 0.004	0.071 ± 0.004	0.059 ± 0.004	12.992 ± 0.039	2.953 ± 0.039	0.531 ± 0.002

SPB	SYMBOL	E	F	P	P0	P1	T	W	W1
	(mm)	1.75 ± 0.10	7.50 ± 0.05	16.00 ± 0.05	4.00 ± 0.05	2.00 ± 0.05	0.30 ± 0.05	16.00 ± 0.10	17.00 ± 1.00
	(inch)	0.069 ± 0.004	0.295 ± 0.002	0.630 ± 0.002	0.157 ± 0.002	0.079 ± 0.002	0.012 ± 0.002	0.630 ± 0.004	0.669 ± 0.039

Company reserves the right to improve product design, functions and reliability without notice.

REV:A

## Marking Code

Part Number	Marking code
CSPB40K-HF	SPB40K

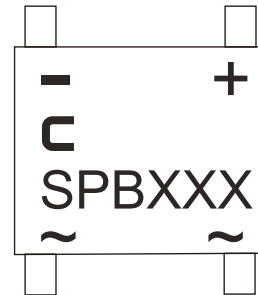

XXX = Product type marking code  
C = Comchip Logo

## Suggested PAD Layout

SIZE	SPB	
	(mm)	(inch)
A	1.63	0.064
B	1.87	0.074
C	5.10	0.201
D	11.80	0.465

Note: 1. The pad layout is for reference purposes only.

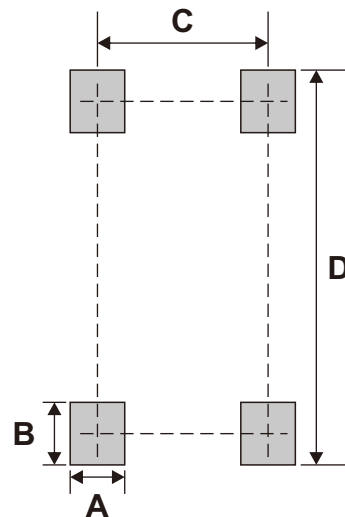

## Standard Packaging

Case Type	REEL PACK	
	REEL ( pcs )	Reel Size (inch)
SPB	1,500	13